

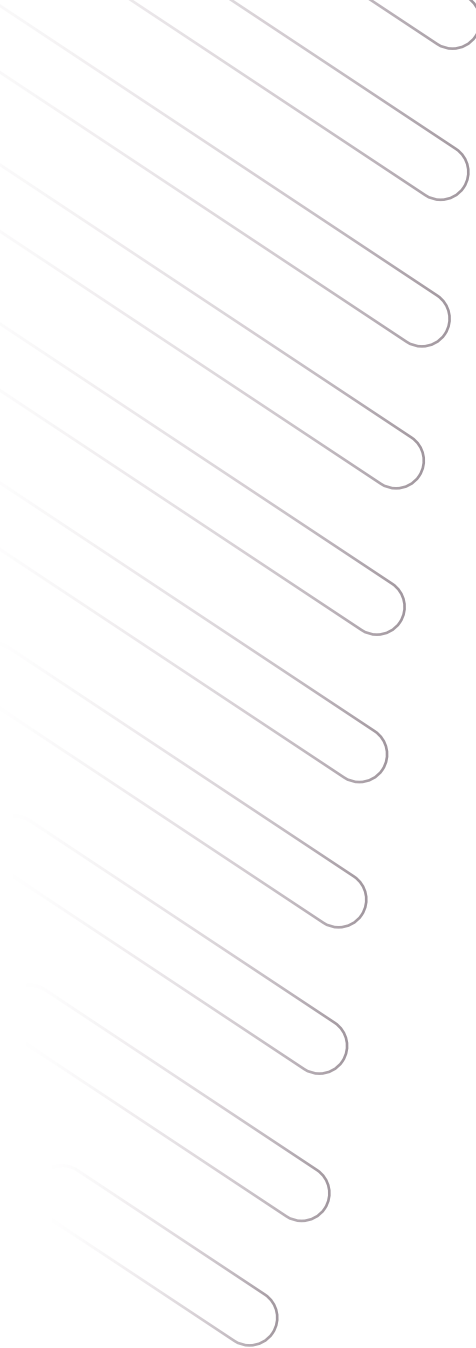

CORTEXTM
The Future of Dental Implants

Product Catalogue



CORTEXTM
The Future of Dental Implants

CORTEX Dental Implants Industries Ltd.

Industrial Zone Shlomi, 26 Ya'ara st. P.O.BOX 125, 2283202 \\ Tel. +972-4-9873970 \\ Fax. +972-4-9873972
www.cortex-dental.com \\ info@cortex-dental.com

What we stand for

In everything we do, our primary focus is you:
dental experts, experienced and fresh out of dental school alike.
The torchbearers of the dental revolution.

We understand you and the challenges you face:
Your desire to continuously improve and be at the forefront of dental practice.
Your aim to be as efficient as possible, to serve more patients in less time, to provide better medical care, and to grow your practice.

Your drive to thrive

With a deep understanding of the demands of dentistry, backed by an expert, in-house R&D team, we combine new and proven methods with cutting-edge technology to provide you with effective tools to strengthen your practice and give you a competitive advantage.

Through product innovation, personal guidance, and dedicated service, we promise:

- Shorter chair times, improved output and greater profits
- Products made from the highest-quality raw materials the market has to offer
- Solutions that suit the vast majority of clinical requirements
- Proven and registered patents
- Information centers available to our dentists

Who is Cortex and what do we do?

Over the past 2 decades, Cortex has established a well-earned reputation as a trailblazer in the dental implantology field. We have done so with great passion, expertise, and outstanding professionalism.

- At the core of our business is the design and production of dental implants, prosthetics, surgical tools, kits, and digital dentistry products and solutions.
- Our products and solutions are certified by the world's most important regulatory authorities, including the FDA, CE, and CFDA.
- Our in-house R&D team is made up of dental engineering experts and world-renowned doctors and surgeons who have a deep understanding of both the market and the clinical aspects of dentistry.
- Our development center and management team are located in Israel, with subsidiaries in China, Columbia, and the U.S.A, and with worldwide reach through a network of distributors.
- We boast an impressive portfolio that includes multiple international patents which we have specifically adapted to each procedure and each situation that may arise in the dental practice and dental laboratories.
- Last but not least, our service department is led by members of our dedicated customer service team, who are motivated to swiftly provide the best possible service to each dentist and each clinic, wherever Cortex is found.

We always have you in mind:

1. Innovative and patented Implants that will enable you to ensure better bone preservation with a drill-less procedure that will save you chair time dramatically.
2. User friendly surgical kits with DLC Coated drills offering up to 3 times longer life span for the drills with less friction and heat production.
3. Digital case planning system and service that will offer solutions to any clinical case and provide you with a wonderful selling platform for the patient.
4. The most advanced and user friendly guided surgery system that will save you up to 50% in chair time and reduce potential errors to almost 0.3%.

Content

Introduction	7
Quality Assurance	9
Conical Platform	10
Implants	11
- Dynamix	
- Classix	
- Magix	
Labeling	16
Prosthetic components	17
Abutments	18 - 22
- Healing Cap Abutments	
- Titanium Cover Screws	
- Abutments Screw Long	
- Titanium Abutments	
- Premium Straight Abutments	
- Anatomic Straight Abutments	
- Angulated Abutments 15°	
- Angulated Abutments 25°	
- Anatomic Angulated Abutments 15°	
- Anatomic Angulated Abutments 25°	
- Low Profile Abutments	
- Temporary Abutments PEEK	
- Castable Abutments	
Impression Components	23
Implant Analogs	24
Ball Attachment System	24
Multi-Units	25
Internal HEX Platform	28
Cortex Implant Packaging	29
- Prime	
- Premium	
Implants	30 - 33
- Dynamix	
- Classix	
- Saturn	
- Smart 1 Piece	

Labeling	34
Prosthetic components	35
Abutments	36 - 38
- Healing Cap Abutments	
- Titanium Anatomic Abutments	
- Titanium Standard Abutments	
- Titanium Slim Abutments	
- Temporary Anatomic Abutments PEEK	
- Castable Anatomic Acetal Abutments	
- Custom Castable Abutments	
Aesthetic Connection Abutments	39
Impression Components	40
Analogs	41
Titanium Screws	41
Ball Attachment System	42
Multi-Units	43
Digital Solutions	45
Guided Surgery	46
Guided Surgery Kit Layout	
Implant Site Preparation	
Guided Surgery Drills And Tools	
Components For Model Analog	
CAD/CAM	53 - 61
Introduction	
Scan Body	
Ti-Base - Lock (Engaged)	
Ti-Base - No Lock (Non Engaged)	
Multi-Unit Ti-Base	
Pre-Milled Abutments	
CEREC Compatible Components	

Surgical Instruments	61
Surgical Kits Internal Hex Platform	62
- Basic	
- Prime	
- Premium	
Surgical Kit Conical Platform	63
- Conical Surgical Kit	
Extension Kits	63
- Hex Extension Kit	
- MPN Extension Kit	
- MPR/MPW Extension Kit	
Drills	64
- Drilling Sequence	
Stoppers Kits	66
- Prime	
- Premium	
General Tools	67
Appendix	70
Reference Table	71

Introduction

Material

Cortex Dental Implants Industries Ltd. uses Titanium Alloy Ti 6Al-4V ELI, a material proven to be highly successful in the fabrication of dental implants. The ELI grade has superior damage tolerance (fracture toughness, fatigue crack growth rate) and better mechanical properties at cryogenic temperatures compared to standard grade Ti 6Al-4V, therefore, it is the perfect choice for implant fabrication. Its mechanical strength (40% stronger than grade 4) allows flexibility in implant design geometry. Ti 6Al-4V ELI is highly resistant to corrosion as it spontaneously and immediately forms a stable, continuous, tightly adherent oxide film upon exposure to oxygen in air or water, which protects the underlying metal from further oxidation and corrosion.

Surface Treatment

The surface roughness and Nano-morphology of Cortex Dental implants are achieved by blasting the implants with Al_2O_3 , followed by etching with a combination of acids. This process increases the overall surface area and improves the interlocking between mineralized bone and implant surface while modifying the surface chemistry.



50 times magnification



400 times magnification

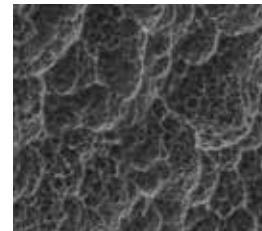

3000 times magnification

Laboratory Tests: Cortex routinely carries out all of the necessary laboratory tests to ensure that implant production and surface treatments remain constantly, and consistently at the highest quality standard. Cortex holds collaborations with many well respected academic institutions worldwide, and we invest efforts and resources in testing and research, to achieve maximum validation and verification.

XPS atomic concentrations (%)

Titanium Oxide thickness (nm)	O	Ti	C	Al	V	N
4.0	56.71	18.79	20.05	3.80	0.40	0.25

* Titanium Oxide average – $56.71 + 18.79 = 75\%$.

Primary Stability

Implant geometry and surface treatments play a critical role in the primary fixation and long-term mechanical stability. Surface optimizations allow greater Bone-to-Implant-Contact which enhance the growth rate of new bone during the remodeling process. Optimal surface roughness provides an ideal environment for protein absorption and cell attachment.

Quality Control

All Cortex products are subjected to strict quality control tests, in all stages of production, starting with raw materials inspection, continuing up to packaging and shipment. Products are marked with batch numbers, together with the relevant raw material for traceability.

Sterilization

Cortex implants undergo a thorough Gamma irradiation sterilization procedure and meets the highest regulatory and clinical requirements. Our implants have a 5-year validity period.

Warranty

Cortex is completely confident in the quality of its delivered products, and therefore we offer a lifetime guarantee on all of our implants. (As long as it is used in accordance with our instructions for use).

High Initial Stability

- Conical implant core and wide thread with double lead provide higher bone grip for enhanced initial stability
- Implant coronal part features additional two micro-threads overlapping with the main threads for enhanced Cortical bone grip
- Ideal for sinus lift procedures
- Enables Immediate Loading

Optimal Bone Grip & Compression

- Vertical and horizontal bone compression resulting in active bone contact
- **Horizontal Bone Compression**
Achieved by the conical design of the implant's core
- **Vertical Bone Compression**
Achieved by a gradual thickening of the implant's external threads



Locking Elements - Patented

- Provides enhanced resistance to counter-clockwise rotational torques during the prosthetic rehabilitation process

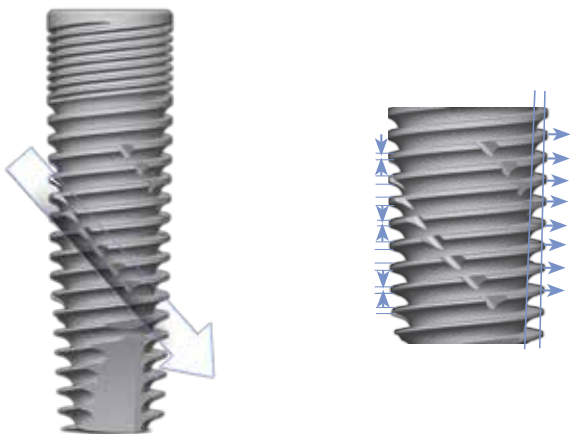

Quality Assurance

Cortex Implants Regulatory Compliance

Cortex Dental Implants Industries Ltd. is ISO 13485 certified, and holds CE Mark by BSI NB (CE 2797) as well as 510k clearance for sales in the US.



- FDA CLEARED
- EN ISO 13485
- **CE** 2797
- NMPA (CFDA)
- ROSZDRAVNADZOR
- ISRAELI MINISTRY OF HEALTH
- INVIMA
- COFEPRIS

Conical Platform



Implants

Conical Connection

- High accuracy Conical Interface
- Dedicated tooling system
- Double internal hexagon allows 12-prosthetic positioning options
- Conical connection dramatically reduce micro-gap
- Color coded Narrow, Regular and Wide platforms



Maximum Accuracy, Minimum Complications

Cortex Conical Platform offers maximum accuracy and flexibility. Designed to decrease unpredicted complications, it is simple and easy to use; suitable for all indications and positions; and perfect for one- and two- stage procedures and immediate loading. Cortex Conical Platform continues Cortex's tradition of high quality, reliable, and easy-to-use products.

Prosthetic Components

Cortex's range of prosthetic components provides clinicians all the needed tools for screw retained, cemented, and removable restorations.

Micro Movements (micro-gap) of Implant-Abutment Interface

Department Of Prosthetic Dentistry; J.W. Goethe University Frankfurt am Main; Prof. Dr. H. Ch. Lauer.

- With other types of degreed conical implant-abutment connection, it was found that several brands showed a micro-gap.
- The conical Dynamix Ø 4.2, manufactured by Cortex, showed no micro gap as it does in other dental implant systems.
- No micro-gap in the Cortex conical implant-abutment connection.

Golden Ratio

Golden Ratio in Implants

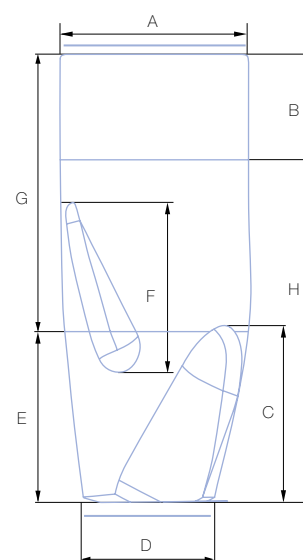
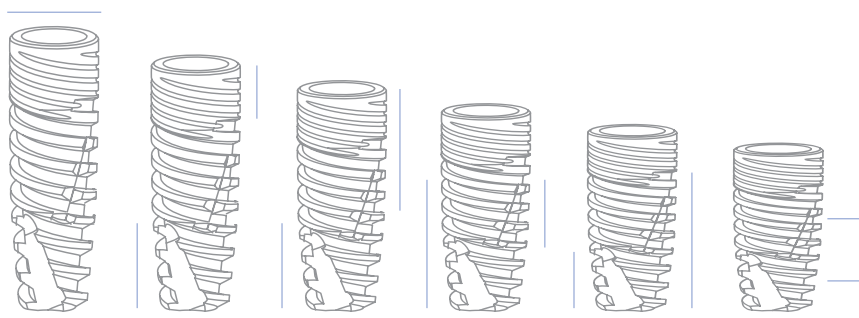

Best preservation of bone quantity and improved bone quality.

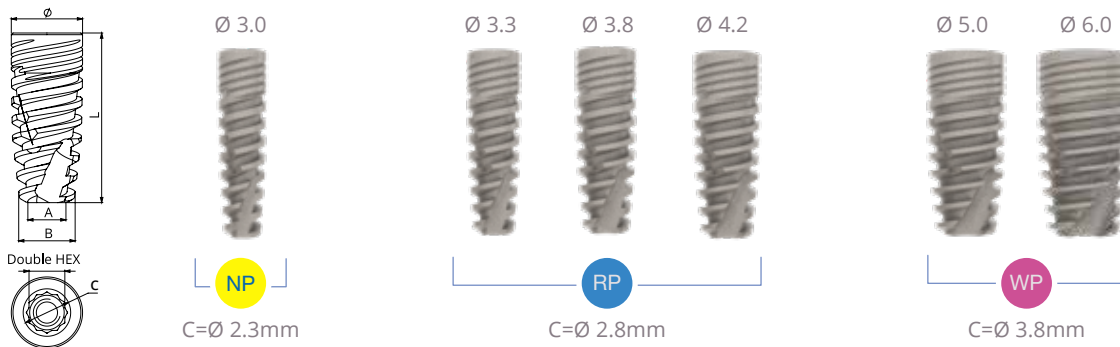

Dynamix Conical Narrow Platform - Prime Package

Implant Diameter Ø [mm]	Double HEX [mm]	A [mm]	B [mm]	L = 6 [mm]	L = 8 [mm]	L = 10 [mm]	L = 11.5 [mm]	L = 13 [mm]	L = 16 [mm]	
3.0	1.7	1.3	2.3				BMCD-1030	BMCD-1130	BMCD-1330	BMCD-1630

Dynamix Conical Regular Platform - Prime Package

Implant Diameter Ø [mm]	Double HEX [mm]	A [mm]	B [mm]	L = 6 [mm]	L = 8 [mm]	L = 10 [mm]	L = 11.5 [mm]	L = 13 [mm]	L = 16 [mm]	
3.3	2.1	1.6	2.6				BMCD-1033	BMCD-1133	BMCD-1333	BMCD-1633
3.8	2.1	1.9	2.9			BMCD-0838	BMCD-1038	BMCD-1138	BMCD-1338	BMCD-1638
4.2	2.1	2.2	3.2	BMCD-0642	BMCD-0842	BMCD-1042	BMCD-1142	BMCD-1342	BMCD-1642	

Dynamix Conical Wide Platform - Prime Package

Implant Diameter Ø [mm]	Double HEX [mm]	A [mm]	B [mm]	L = 6 [mm]	L = 8 [mm]	L = 10 [mm]	L = 11.5 [mm]	L = 13 [mm]	L = 16 [mm]
5.0	2.5	2.8	3.8	BMCD-0650	BMCD-0850	BMCD-1050	BMCD-1150	BMCD-1350	
6.0	2.5	3.8	4.6	BMCD-0660	BMCD-0860	BMCD-1060	BMCD-1160		

Recommended for:

All surgical procedures. Positions: maxilla & mandible. Ideal for D2-D4 bone types.

Excellent Bone Cutting Capacity

- Bone preservation
- Easy bone penetration
- Two milling cutting edges
- Sharp and precise bone cutting
- Ability to change penetration angle during implantation in case of incorrect pre-drilling by Self-drilling and Self-tapping

CLASSIX

Ideal bone to implant contact

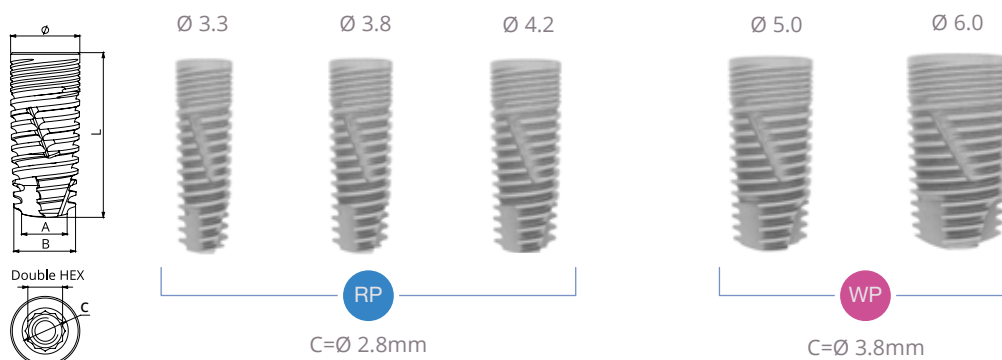

Classix Conical Regular Platform - Prime Package

Implant Diameter Ø [mm]	Double HEX [mm]	A [mm]	B [mm]	L = 6 [mm]	L = 8 [mm]	L = 10 [mm]	L = 11.5 [mm]	L = 13 [mm]	L = 16 [mm]
3.3	2.1	2.0	3.2			BMCC-1033	BMCC-1133	BMCC-1333	BMCC-1633
3.8	2.1	2.5	3.7		BMCC-0838	BMCC-1038	BMCC-1138	BMCC-1338	BMCC-1638
4.2	2.1	2.7	4.0	BMCC-0642	BMCC-0842	BMCC-1042	BMCC-1142	BMCC-1342	BMCC-1642

Classix Conical Wide Platform - Prime Package

Implant Diameter Ø [mm]	Double HEX [mm]	A [mm]	B [mm]	L = 6 [mm]	L = 8 [mm]	L = 10 [mm]	L = 11.5 [mm]	L = 13 [mm]	L = 16 [mm]
5.0	2.5	3.5	4.9	BMCC-0650	BMCC-0850	BMCC-1050	BMCC-1150	BMCC-1350	
6.0	2.5	4.4	5.9	BMCC-0660	BMCC-0860	BMCC-1060	BMCC-1160		

Recommended for:

All surgical procedures, Mandible and Maxilla, Ideal for D1-D3 bone types.

Excellent Bone Cutting Capacity

- Narrow, long and sharp apical starting thread
- Two thread beginnings and three milling cutting edges
- Easy bone penetration
- Precise cutting and Self-tapping
- Improved bone condensation and preservation

Magix Implant - Ideal implant for Drill-Less approach

- An exceptional solution for drill less approach, for bone preservation and condensation.
- The Magix Implant is self-drilling, self-tapping and self bone condensing, with outstanding advantages in medium to soft bones.
- The Magix Implant design consists of single lead thread, tapered implant with a conical connection.
- The combination of design features enables easy and fast insertion and very high primary stability.
- Compatible with screw-retained, cement-retained, and overdenture restorations.

Immediate Implant Placement

Immediate implant placement is defined by the International Congress of Oral Implantologists (ICOI) as the placement of an implant at the time of tooth extraction, into the extraction socket.

Magix Implants can be placed immediately if the following criteria are observed:

- Seventy-five (75%) percent of the implant engages freshly prepared bone.
- The implant supports the buccal or labial bone.
- All existing pathology in the socket must be removed until there is no acute infection. If an infection is still present, it must be treated appropriately and the site cleaned and allowed to heal for four to six weeks before the implant is placed.
- Labial plate is intact.
- Crown does not exceed the recommended crown-to-root ratio (1:1).
- The diameter of the implant at the crest of the extraction site should be as wide as possible to prevent tissue in-growth.
- Immediate Provisionalization: Non-occlusal Load Immediate provisionalization is defined by the International Congress of Oral Implantologists (ICOI) as a clinical protocol for the placement of an interim prosthesis, with or without occlusal contact with the opposing dentition, at the same clinical visit as implant placement.

Magix Implants can be fitted with a temporary restoration at the time of implant placement if the following criteria are observed:

- Final implant tightening has a torque resistance of 35 - 45Ncm.
- No occlusal contacts in excursive movements and only light contact in centric occlusion.
- Good bone volume and density (recommended in Types I, II and III).
- Angulation of the implant does not exceed 15°.

Important Warning

Lack of adequate practitioner training is a major risk factor that prevents the success of the implant and its procedure, and may endanger patient health. Therefore, no implantation should be performed without prior adequate training by a certified institute.

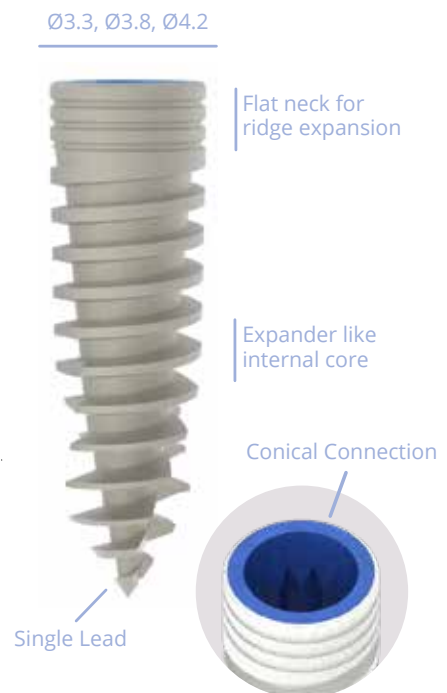

Ideal for implant placement without drilling



Magix Conical Regular Platform - Prime Package

Implant Diameter Ø [mm]	Double HEX [mm]	A [mm]	B [mm]	L = 8 [mm]	L = 10 [mm]	L = 11.5 [mm]	L = 13 [mm]	L = 16 [mm]
3.3	2.1	1.6	2.6	BCDL-0833	BCDL-1033	BCDL-1133	BCDL-1333	BCDL-1633
3.8	2.1	1.9	2.9	BCDL-0838	BCDL-1038	BCDL-1138	BCDL-1338	BCDL-1638
4.2	2.1	2.2	3.2	BCDL-0842	BCDL-1042	BCDL-1142	BCDL-1342	BCDL-1642

Recommended for:

All procedures.

Positions: maxilla & mandible. Drill-less approach is not recommended for hard bone type!

Excellent Bone tissue Penetration and Preservation

- Bone tissue preservation.
- Compressing the bone to create a denser bone around the implant.
- Higher initial stability.
- Prevention of rotary sliding of the implant (spinner implant).
- Reduced risk arising from drilling.
- Reduce patient discomfort.
- Shorter drilling protocol.
- Less risk of bone perforation or fenestration.

Labeling

Capsule Diameter Color Coding



Ø 3.0



Ø 3.3 Ø 3.8 Ø 4.2



Ø 5.0 Ø 6.0

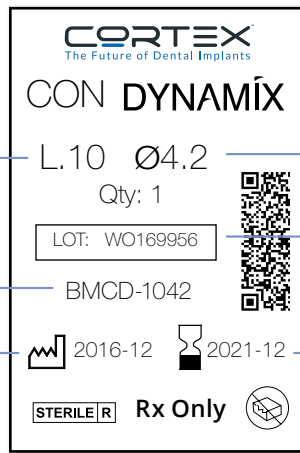

Length of the implant

L.10 Ø4.2

Diameter of the implant

Qty: 1

Catalog number

LOT: WO169956

LOT/Batch number

BMCD-1042

Manufacture date (YYYY-MM)

2016-12 2021-12

Expiration date (YYYY-MM)

STERILE R Rx Only

Marks on Package



Cortex products are CE Certified and comply with European Union requirements.



Do not reuse



Do not resterilize



Method of sterilization using radiation



Keep away from sunlight



Do not use if package damaged



Caution, consult accompanying documents

Rx Only Prescription device

Manufacturer:

Cortex Dental Implants industries Ltd.
 Shlomi Industrial Zone, 26 Ya'ara st., Shlomi 22832 Israel.
 Tel: +972-4-987-3970, Fax: +972-4-987-3972 | www.cortex-dental.com



EMERGO EUROPE
 Prinsessegracht 20
 2514 AP The Hague
 The Netherlands

Prosthetic components

Abutments



Ø 3.0



Ø 3.3 Ø 3.8 Ø 4.2



Ø 5.0 Ø 6.0

Healing Cap Abutments

Laser marking

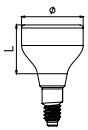

Length	Ø 3.8 [mm]	Ø 4.6 [mm]	NEW Ø 6.0 [mm]	Ø 5.8 [mm]	NEW Ø 7.0 [mm]
2 mm	MPN-8102	MPR-7102			
3 mm	MPN-8103	MPR-7103	MPR-7503	MPW-7503	MPW-7603
4 mm	MPN-8104	MPR-7104		MPW-7504	
5 mm	MPN-8105	MPR-7105	MPR-7505	MPW-7505	MPW-7605
6 mm	MPN-8106	MPR-7106		MPW-7506	
7 mm	MPN-8107	MPR-7107	MPR-7507		MPW-7607

* Titanium Alloy (Ti 6Al-4V ELI) hand tighten with the 1.25 hex driver.

Titanium Cover Screws



Head Ø 2.3 [mm]	Head Ø 2.8 [mm]	Head Ø 3.8 [mm]
MPN-S010	MPR-S010	MPW-S010
M1.4	M1.6	M2

* Titanium Alloy (Ti 6Al-4V ELI) hand tighten with the 1.25 hex driver.

* For use during submerged /two-stage procedures. Included with the implant.

Abutment Screw



Head Ø 2.0 [mm]	Head Ø 2.3 [mm]	Head Ø 2.3 [mm]
MPN-S030	MPR-S030	MPW-S030
M1.4	M1.6	M2

* Includes abutments.

* Use the 1.25 mm hex driver.

* Titanium Alloy - Ti 6Al-4V ELI.

* Final torque - RP,WP 30 Ncm.

* Final torque NP 20 Ncm.

Abutments



Ø 3.0



Ø 3.3 Ø 3.8 Ø 4.2



Ø 5.0 Ø 6.0

Titanium Abutments

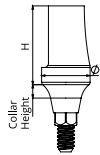

Height	Ø 3.8 [mm]	Ø 4.8 [mm]	Ø 5.8 [mm]
7 mm	MPN-8000	MPR-8000	MPW-8000
	Collar Height 1.5 mm	Collar Height 1.5 mm	Collar Height 1.5 mm

Premium Straight Abutments

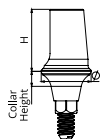

Height	Ø 4.8 [mm]	Ø 4.8 [mm]	Ø 4.8 [mm]
7.5 mm	MPN-8036	MPR-8036	MPW-8036
	Collar Height 1.5 mm	Collar Height 1.5 mm	Collar Height 1.5 mm

Anatomic Straight Abutments

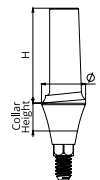

Collar Height	Ø 3.85 [mm]	Ø 4.6 [mm]	Ø 5.8 [mm]
1 mm	MPN-9001	MPR-9001	MPW-9001
2 mm	MPN-9002	MPR-9002	MPW-9002
3 mm	MPN-9003	MPR-9003	MPW-9003
4 mm	MPN-9004	MPR-9004	MPW-9004
Height	10 mm	10 mm	7 mm

* Final torque - RP, WP 30 Ncm.

* Final torque NP 20 Ncm.

Note:

- Used for cement retained without, single or multiple prosthetic units.
- Titanium Alloy (Ti 6Al-4V ELI).
- Includes abutment screw MPN-S030 / MPR-S030 / MPW-S030.

Abutments



Ø 3.0



Ø 3.3 Ø 3.8 Ø 4.2



Ø 5.0 Ø 6.0

Angulated Abutments 15°

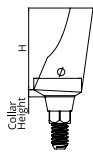

Height	Ø 3.8 [mm]	Ø 4.7 [mm]	Ø 5.8 [mm]
8 mm	MPN-8115	MPR-8115	MPW-8115
	Collar Height 1mm	Collar Height 1mm	Collar Height 1mm

Angulated Abutments 25°

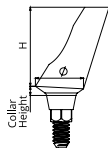

Height	Ø 3.8 [mm]	Ø 4.8 [mm]	Ø 6.8 [mm]
8 mm	MPN-8125	MPR-8125	MPW-8125
	Collar Height 1mm	Collar Height 1mm	Collar Height 1mm

Anatomic Angulated Abutments 15°

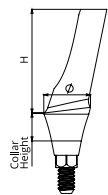

Collar Height	Ø 3.9 [mm]	Ø 4.9 [mm]	Ø 6 [mm]
1 mm	MPN-9115	MPR-9115	MPW-9115
2 mm	MPN-9215	MPR-9215	MPW-9215
3 mm	MPN-9315	MPR-9315	MPW-9315
4 mm	MPN-9415	MPR-9415	MPW-9415
Height	10 mm	10 mm	7 mm

* Lingual step increases up to 1mm.

* Final torque - RP,WP 30 Ncm.

* Final torque - NP 20 Ncm.

Note:

- Used for cement retained of single or multiple prosthetic units.
- Titanium Alloy (Ti 6Al-4V ELI).
- Includes abutment screw MPN-S030 / MPR-S030 / MPW-S030.

Abutments



Ø 3.0



Ø 3.3 Ø 3.8 Ø 4.2



Ø 5.0 Ø 6.0

Anatomic Angulated Abutments 25°

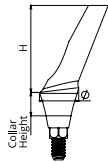

Collar Height	Ø 3.9 [mm]	Ø 4.9 [mm]	Ø 6 [mm]
1 mm			MPW-9125
2 mm	MPN-9225	MPR-9225	MPW-9225
3 mm	MPN-9325	MPR-9325	MPW-9325
4 mm	MPN-9425	MPR-9425	MPW-9425
Height	10 mm	10 mm	7 mm

* Lingual step increases up to 1mm.

* Used for cement retained, single or multiple prosthetic units.

* Includes abutment screw MPN-S030/MPR-S030/MPW-S030.

* Titanium Alloy (Ti 6Al-4V ELI).

* Final torque - RP,WP 30 Ncm.

* Final torque - NP 20 Ncm.

Low Profile Abutment Regular Platform

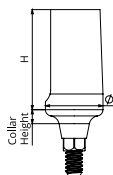

Height	Ø 5.5 [mm]	Ø 7 [mm]
10 mm	MPR-0055	MPR-0070
	Collar Height 1.5 mm	Collar Height 1.5 mm

* Used for cement retained, single, or multiple prosthetic units.

* Includes abutment screw MPR-S030

* Titanium Alloy (Ti 6Al-4V ELI).

* Final Torque 30 Ncm.

Abutments

Temporary PEEK Abutments



Ø 3.0



Ø 3.3 Ø 3.8 Ø 4.2



Ø 5.0 Ø 6.0

Straight Abutment

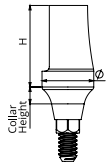

Collar Height	Ø 3.8 [mm]	Ø 4.8 [mm]	Ø 5.8 [mm]
1.5 mm	MPN-PA00	MPR-PA00	MPW-PA00
Height	7 mm	7 mm	7 mm

Angulated Abutment 15°

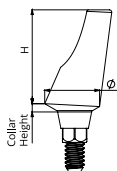

Collar Height	Ø 3.8 [mm]	Ø 4.7 [mm]	Ø 5.8 [mm]
1 mm	MPN-PA15	MPR-PA15	MPW-PA15
Height	8 mm	8 mm	8 mm

Angulated Abutment 25°

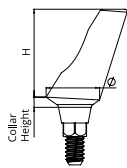

Collar Height	Ø 3.8 [mm]	Ø 4.7 [mm]	Ø 5.8 [mm]
1 mm	MPN-PA25	MPR-PA25	MPW-PA25
Height	8 mm	8 mm	8 mm

* Final torque - RP, WP 25 Ncm.

* Final torque - NP 20 Ncm.

Note:

- Used for cement or screw retained provisional restorations.
- Used for immediate loading single or multiple.
- Includes abutment screw MPN-S030 / MPR-S030 / MPW-S030.
- PEEK (Polyetheretherketone).

Castable Abutments



Custom Titanium Castable Abutments (UCLA) Hexed

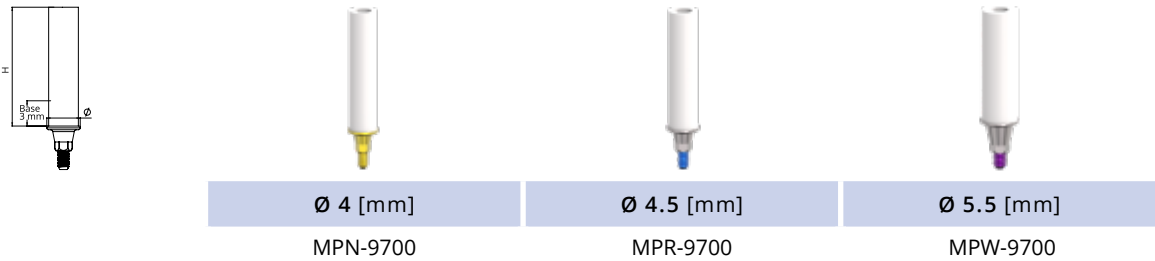

Custom Titanium Castable Abutments (UCLA) Non Hexed

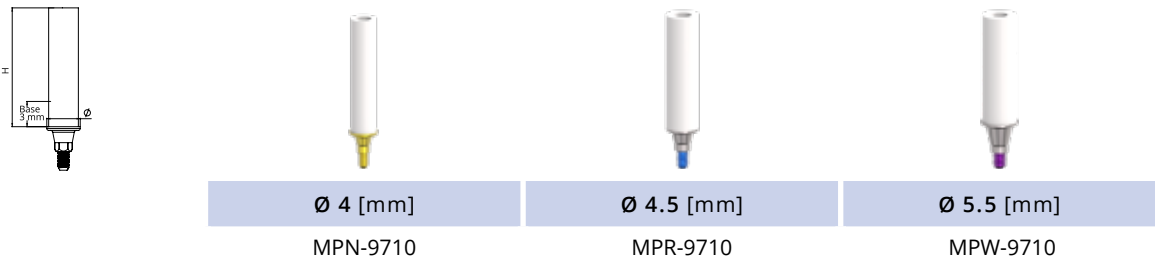

Custom CrCo Castable Abutments (UCLA) Hexed

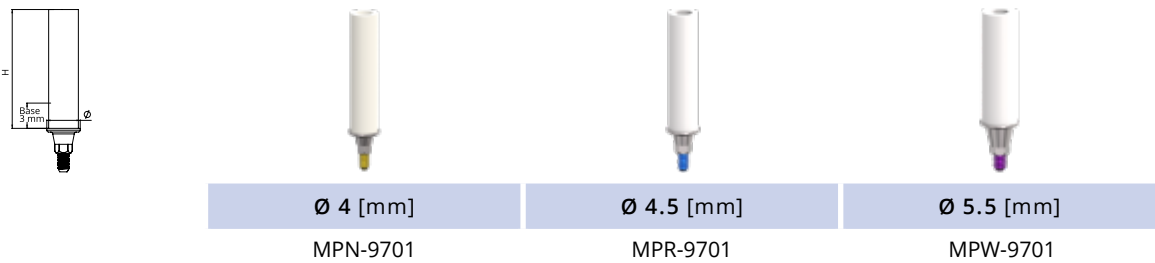

Custom CrCo Castable Abutments (UCLA) Non Hexed

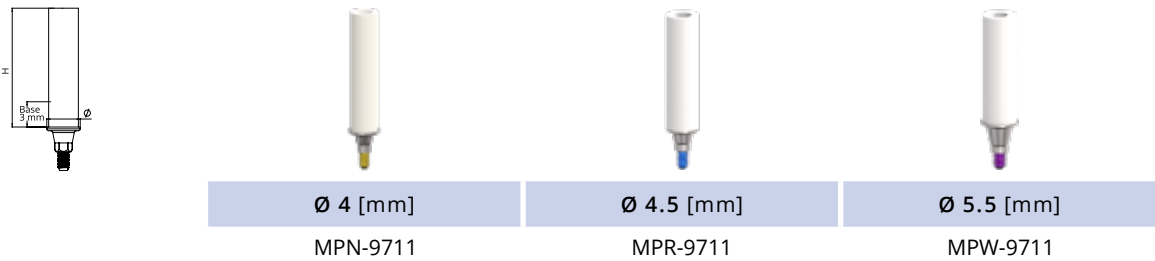

- * $H = 17$ [mm]
- * Final torque - RP, WP 30 [Ncm]
- * Final torque - NP 20 [Ncm]

Note:

- Used for cement or screw retained, single prosthetic units (Hexed), bridge or multiple units (Non Hexed).
- Includes abutment screw MPN-S030 / MPR-S030 / MPW-S030.
- Titanium base (Ti 6Al-4V ELI) or Chrome Cobalt base with Delrin® sleeve.

Impression Components



Ø 3.0



Ø 3.3 Ø 3.8 Ø 4.2



Ø 5.0 Ø 6.0

Direct Transfer Copings (open tray)

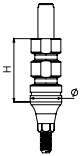

Height	Ø 4 [mm]	Ø 4.5 [mm]	Ø 5.2 [mm]
11 mm	MPN-8060	MPR-8060	MPW-8060

* Flat slot screw for easy access.

- Includes compatible screw: MPN-S060/MPR-S060/MPW-S060

Indirect Short Transfer Copings (closed tray)

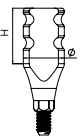

Height	Ø 3.7 [mm]	Ø 4.7 [mm]	Ø 4.7 [mm]
9 mm	MPN-8080	MPR-8080	MPW-8080

- Includes compatible screw: MPN-S040/MPR-S040/MPW-S040

Indirect Long Transfer Copings (closed tray)

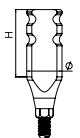

Height	Ø 3.7 [mm]	Ø 4.7 [mm]	Ø 4.7 [mm]
12 mm	MPN-8085	MPR-8085	MPW-8085

* Final torque - RP,WP 25 Ncm.





* Final torque - NP 20 Ncm.

- Includes compatible screw: MPN-S070/MPR-S070/MPW-S070



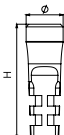

Note:

- Includes a compatible screw which is not available separately.
- Used to take an open / closed tray, implant level impression.
- Hand tighten with the 1.25 mm hex driver.
- Titanium Alloy (Ti 6Al-4V ELI).

Implant Analog

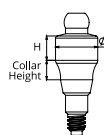
	NP Ø 3.0	RP Ø 3.3 Ø 3.8 Ø 4.2	WP Ø 5.0 Ø 6.0
			
Height	Ø 4.2 [mm]	Ø 4.2 [mm]	Ø 5 [mm]
13 [mm]	MPN-8040	MPR-8040	MPW-8040

Ball Attachment System

	Ø 3.8 [mm]	Ø 3.8 [mm]	Ø 4.5 [mm]
			
Collar Height	MPN-6201	MPR-6201	MPW-6201
1 [mm]	MPN-6202	MPR-6202	MPW-6202
2 [mm]	MPN-6203	MPR-6203	MPW-6203
3 [mm]	MPN-6204	MPR-6204	MPW-6204
4 [mm]	MPN-6205	MPR-6205	MPW-6205
5 [mm]	MPR-6206	MPR-6206	MPW-6206
6 [mm]	MPR-6207	MPR-6207	
7 [mm]			

* Used for retention of removable overdentures.

* Titanium alloy (Ti 6Al-4V ELI).

* Final torque - RP,WP 30 Ncm.

* Final torque - NP 20 Ncm.

Metallic Attachment Housing (Cap)

	Diameter Ø	Height	Cat. Number
	4 [mm]	2.65 [mm]	CO-0630
	* Used for overdentures pickup or soldering.		
	* Titanium alloy (Ti 6Al-4V ELI).		
	* Ball diameter: Ø2.25[mm]		

POM (Polyacetal) Silicon Cap

	Color	Retention	Cat. Number
	Yellow	Standard	CO-0620
	White	Soft	CO-0621
	Red	Hard	CO-0622
	* For metallic attachment housing CO-0630.		

- Used for retention of tissue supported overdenture.

MULTI-UNIT

The Multi-Unit abutments range features straight bases and bases with angle correction of 18° and 30° and 1-5 mm of collar heights for all implant platforms including narrow implants.

Multi-Unit Conical Abutments



Ø 3.0



Ø 3.3 Ø 3.8 Ø 4.2



Ø 5.0 Ø 6.0

Straight Multi-Unit Abutment

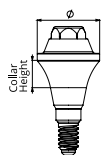

Collar Height	Ø 5 [mm]	Ø 5 [mm]	Ø 5 [mm]
1 mm	MPN-5100	MPR-5100	MPW-5100
2 mm	MPN-5200	MPR-5200	MPW-5200
3 mm	MPN-5300	MPR-5300	MPW-5300
4 mm	MPN-5400	MPR-5400	MPW-5400
5 mm	MPN-5500	MPR-5500	MPW-5500

Angulated Multi-Unit Abutment 18°

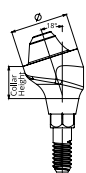

Collar Height	Ø 5 [mm]	Ø 5 [mm]	Ø 5 [mm]
1 mm	MPN-5118	MPR-5118	MPW-5118
2 mm	MPN-5218	MPR-5218	MPW-5218
3 mm	MPN-5318	MPR-5318	MPW-5318
4 mm	MPN-5418	MPR-5418	MPW-5418
5 mm	MPN-5518	MPR-5518	MPW-5518

* Includes screw MPN-MUS65 / MPR-MUS65 / MPW-MUS65 + CT-MUP10 (Ang. Multi-Unit holders)

* Final torque - RP,WP 25 Ncm. * Final torque - NP 20 Ncm.

Angulated Multi-Unit Abutment 30°

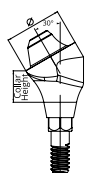

Collar Height	Ø 5 [mm]	Ø 5 [mm]	Ø 5 [mm]
1 mm	MPN-5130	MPR-5130	MPW-5130
2 mm	MPN-5230	MPR-5230	MPW-5230
3 mm	MPN-5330	MPR-5330	MPW-5330
4 mm	MPN-5430	MPR-5430	MPW-5430
5 mm	MPN-5530	MPR-5530	MPW-5530

* Includes screw MPN-MUS65/MPR-MUS65/ MPW-MUS65 + CT-MUP10 (Ang. Multi-Unit holders)



Ø 3.0



Ø 3.3 Ø 3.8 Ø 4.2



Ø 5.0 Ø 6.0

Screw for Angulated Multi-Unit Abutment



Thread	M1.4	M1.6	M2
	MPN-MUS65	MPR-MUS65	MPW-MUS65

Transfer for Multi-Unit Abutment

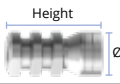
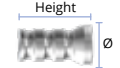
	Diameter Ø	Height	Cat. Number
	5 mm	11 mm	MU-5060
	5 mm	9 mm	MU-5080

* MU-5060 is for open tray. MU-5080 is for close tray.

* Includes screw MU-S060 / MU-S080



Multi-Unit Abutment Analog

	Diameter Ø	Height	Cat. Number
	5 mm	16 mm	MU-8041

Healing Cap for Multi-Unit Abutment

	Material	Feature	Diameter Ø	Height	Cat. Number
	Titanium	Healing Cap	5 mm	4.2 mm	MU-50HC

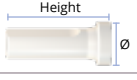
Sleeves for Multi-Unit Abutment

	Material	Feature	Diameter Ø	Height	Cat. Number
	Acetal	Non Hex	5 mm	12 mm	MU-50PL
	Acetal	With Hex	5 mm	12 mm	MU-50SPL
	Titanium	Short	5 mm	7 mm	MU-50TS
	Titanium	Long	5 mm	12 mm	MU-50TL



* All sleeves are Includes screw MU-S020.

Screw for Multi-Unit Abutment

		Thread	Cat. Number
	Screw for Sleeves	M1.4	MU-S020





* Final Torque 15 Ncm.

Multi-Unit Straight Abutments Tighten Key

	Length	Cat. Number
	5 mm	CT-MU01
	10 mm	CT-MU00
	15 mm	CT-MU02

* Final Torque 15 Ncm.

CAD/CAM for Multi-Unit Abutment

		Cat. Number
	Scan Body for Multi-Unit.	CO-SBMU
	Long Ti-Base for Multi-Unit Abutment.	MU-LTSST
	Short Ti-Base for Multi-Unit Abutment.	MU-STSST
	Screw for short Multi-Unit Ti-Base.	MU-S010
	Screw for long Multi-Unit Ti-Base.	MU-S020

* CO-SBMU Includes screw MU-SSB (Hand tightening).

* MU-LTSST Includes screw MU-S020.

* MU-STSST Includes screw MU-S010.

Internal HEX Platform

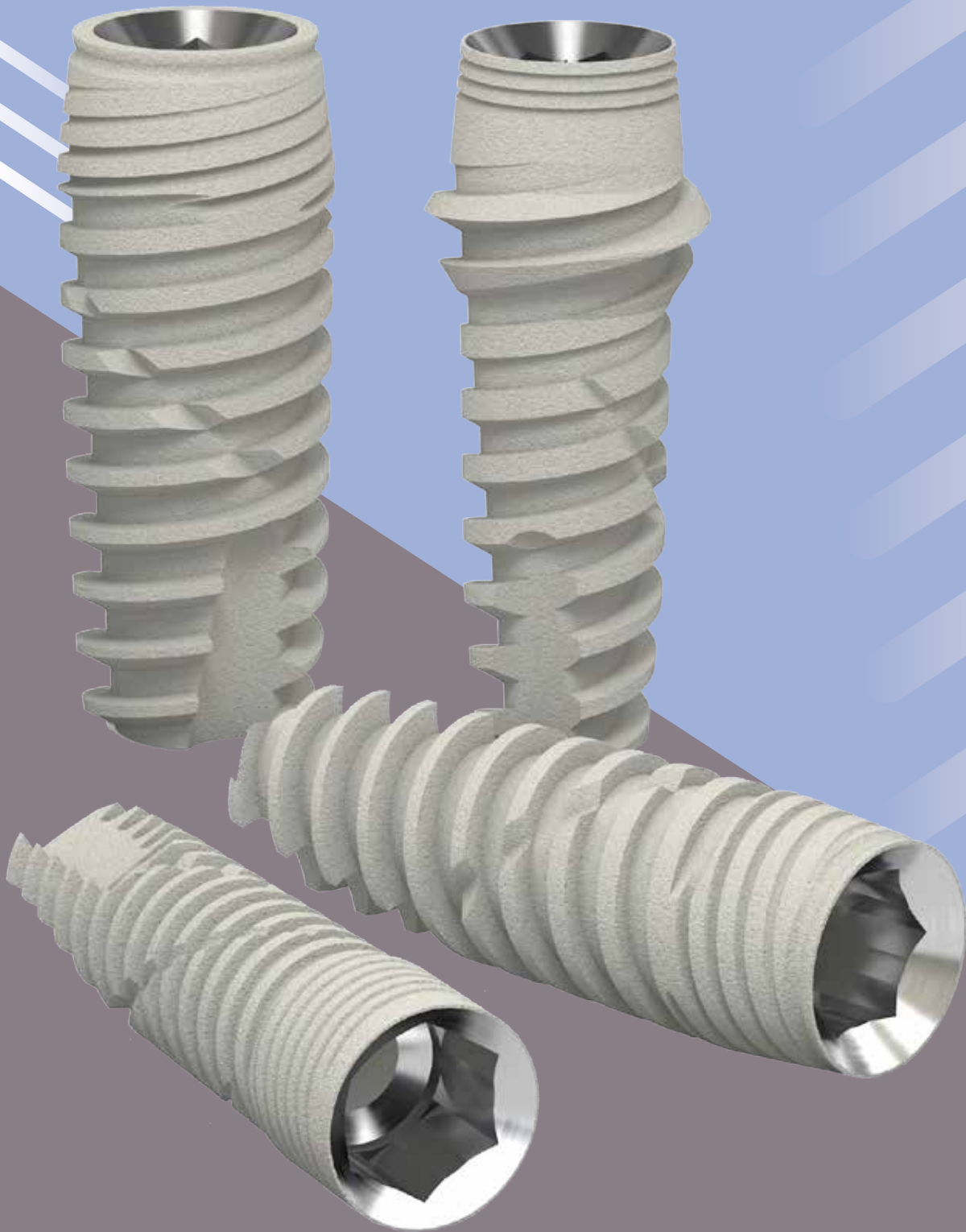

Cortex Implant Packaging

Implant Premium Set

The product is covered by one or more of the following US patents: US 882770.2

* The Prime package refers to Conical & Internal HEX implants, however, the Premium packages refers to Internal HEX implants only.



Surgical Strategies

Allows the implantologists to adopt any implantation strategy during the procedure:

- Two stages (submerge).
- One stage - Metal healing cap.
- Plastic healing cap / Immediate loading.
- Immediate impression.

Cost Effective - 6 Elements in One Packaging

- Cover screw.
- Plastic healing cap.
- Titanium healing cap.
- Transfer.
- Abutment.
- Implant.



Pre Assembled Implant and Abutment

- Direct Mounting of Implant and Abutment (Carrier)



Direct Mounting of Implant and Abutment (Carrier)

- The most sterile way to extract the implant from its case and transfer it to its location.
- Time-saving and easy to use transferring system.



Transfer / Impression Coping

After mounting the sturdy transfer, device is easily separated into two parts:

- The top which can be disposed.
- The impression coping which is used as part of the mplantation procedure.



Mount / Transfer

- Disposable Transfer Top.
- Transfer.

Premium Implant Set Package	
Product Description	Cat. Number
Premium Transfer Connector	PK-N005
Premium Straight Abutment	CO-8036
Screw for Abutment	CO-S030
Dental Implant	PXXX-XXXX
Healing Cap Plastic	PK-N007*
3mm Healing Cap	CO-7103
Surgical Cover Screw	CS-0010

* Not available separately

Implant Prime Set



Prime Implant Set Package (non touch)	
Product Description	Cat. Number
Dental Implant	BXXX-XXXX
Surgical Cover Screw	CS-0010*

Best preservation of bone quantity and improved bone quality.

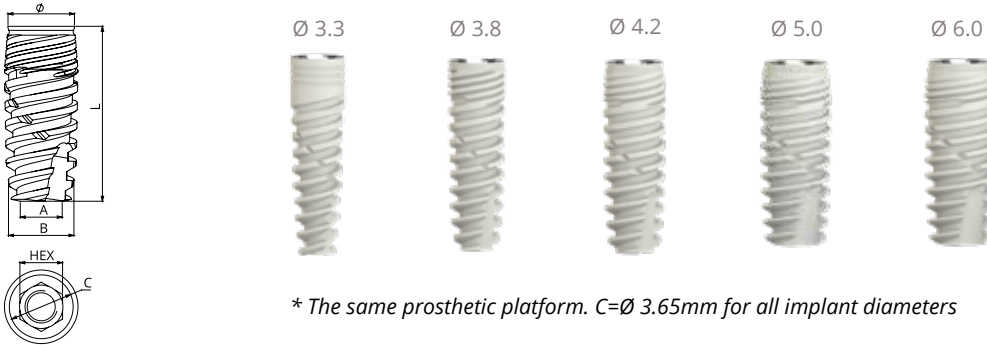

Dynamix Dimensions Premium Package

Implant Diameter Ø [mm]	HEX [mm]	A [mm]	B [mm]	L = 6 [mm]	L = 8 [mm]	L = 10 [mm]	L = 11.5 mm	L = 13 [mm]	L = 16 [mm]
3.3	2.45	1.6	3.0			PCSD-1033	PCSD-1133	PCSD-1333	PCSD-1633
3.8	2.45	2.0	3.4		PCSD-0838	PCSD-1038	PCSD-1138	PCSD-1338	PCSD-1638
4.2	2.45	2.4	3.8	PCSD-0642	PCSD-0842	PCSD-1042	PCSD-1142	PCSD-1342	PCSD-1642
5.0	2.45	3.2	4.6	PCSD-0650	PCSD-0850	PCSD-1050	PCSD-1150	PCSD-1350	
6.0	2.45	4.2	5.6	PCSD-0660	PCSD-0860	PCSD-1060	PCSD-1160	PCSD-1360	

Dynamix Dimensions Prime Package

Implant Diameter Ø [mm]	HEX [mm]	A [mm]	B [mm]	L = 6 [mm]	L = 8 [mm]	L = 10 [mm]	L = 11.5 mm	L = 13 [mm]	L = 16 [mm]
3.3	2.45	1.6	3.0			BCSD-1033	BCSD-1133	BCSD-1333	BCSD-1633
3.8	2.45	2.0	3.4		BCSD-0838	BCSD-1038	BCSD-1138	BCSD-1338	BCSD-1638
4.2	2.45	2.4	3.8	BCSD-0642	BCSD-0842	BCSD-1042	BCSD-1142	BCSD-1342	BCSD-1642
5.0	2.45	3.2	4.6	BCSD-0650	BCSD-0850	BCSD-1050	BCSD-1150	BCSD-1350	
6.0	2.45	4.2	5.6	BCSD-0660	BCSD-0860	BCSD-1060	BCSD-1160	BCSD-1360	

Recommended for:

All procedures. Positions: maxilla & mandible. Ideal for D2-D4 bone types.

Excellent Bone Cutting Capacity

- Narrow, long and sharp apical starting thread.
- Bone preservation.
- Easy bone penetration.
- Precise cutting.
- Milling cutting edges.
- Sharp and precise bone cutting.
- Ability to change penetration angle during implantation in case of incorrect pre-drilling.
- Self-drilling, self-tapping.

CLASSIX

Ideal bone to implant contact.



* The same prosthetic platform C=Ø 3.65mm for all implant diameters

Classix Dimensions Premium Package

Implant Diameter Ø [mm]	HEX [mm]	A [mm]	B [mm]	L = 6 [mm]	L = 8 [mm]	L = 10 [mm]	L = 11.5 mm	L = 13 [mm]	L = 16 [mm]
3.3	2.45	1.8	2.75			PCSC-1033	PCSC-1133	PCSC-1333	PCSC-1633
3.8	2.45	2.2	3.2		PCSC-0838	PCSC-1038	PCSC-1138	PCSC-1338	PCSC-1638
4.2	2.45	2.6	3.6	PCSC-0642	PCSC-0842	PCSC-1042	PCSC-1142	PCSC-1342	PCSC-1642
5.0	2.45	3.4	4.4	PCSC-0650	PCSC-0850	PCSC-1050	PCSC-1150	PCSC-1350	
6.0	2.45	4.4	5.4	PCSC-0660	PCSC-0860	PCSC-1060	PCSC-1160	PCSC-1360	

Classix Dimensions Prime Package

Implant Diameter Ø [mm]	HEX [mm]	A [mm]	B [mm]	L = 6 [mm]	L = 8 [mm]	L = 10 [mm]	L = 11.5 mm	L = 13 [mm]	L = 16 [mm]
3.3	2.45	1.8	2.75			BCSC-1033	BCSC-1133	BCSC-1333	BCSC-1633
3.8	2.45	2.2	3.2		BCSC-0838	BCSC-1038	BCSC-1138	BCSC-1338	BCSC-1638
4.2	2.45	2.6	3.6	BCSC-0642	BCSC-0842	BCSC-1042	BCSC-1142	BCSC-1342	BCSC-1642
5.0	2.45	3.4	4.4	BCSC-0650	BCSC-0850	BCSC-1050	BCSC-1150	BCSC-1350	
6.0	2.45	4.4	5.4	BCSC-0660	BCSC-0860	BCSC-1060	BCSC-1160	BCSC-1360	

Recommended for:

All clinical situations and all bone types.

Excellent Bone Cutting Capacity

- Narrow, long and sharp apical starting thread.
- Two thread beginnings and three milling cutting edges.
- Easy bone penetration.
- Precise cutting and Self-tapping.
- Improved bone condensation.
- Bone preservation.

The ultimate implant for post extraction immediate loading.

Designed by Dr. Zvi Laster DMD

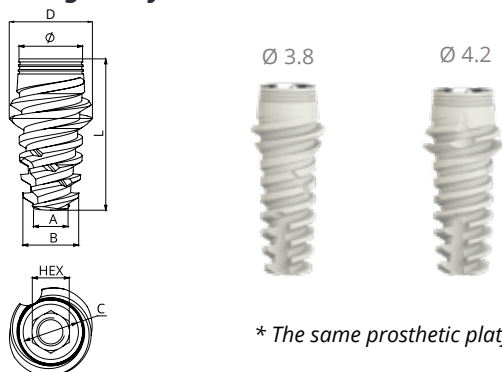

* The same prosthetic platform. C=Ø 3.65mm

Saturn Dimensions Premium Package

Implant Diameter Ø [mm]	HEX [mm]	A [mm]	B [mm]	D [mm]	L = 8 [mm]	L = 10 [mm]	L = 11.5 [mm]	L = 13 [mm]	L = 16 [mm]
3.8	2.45	2.0	3.4	5.3	PST-0838	PST-1038	PST-1138	PST-1338	PST-1638
4.2	2.45	2.4	3.8	6	PST-0842	PST-1042	PST-1142	PST-1342	PST-1642

Saturn Dimensions Prime Package

Implant Diameter Ø [mm]	HEX [mm]	A [mm]	B [mm]	D [mm]	L = 8 [mm]	L = 10 [mm]	L = 11.5 [mm]	L = 13 [mm]	L = 16 [mm]
3.8	2.45	2.0	3.4	5.3	BST-0838	BST-1038	BST-1138	BST-1338	BST-1638
4.2	2.45	2.4	3.8	6	BST-0842	BST-1042	BST-1142	BST-1342	BST-1642

Saturn Implant

Especially suited for immediate loading after extraction, Saturn's "wings" provide substantial initial stability, reducing stress distribution at the alveolar cortex and optimize esthetic restoration. Primary stability of Saturn implant in the empty socket is over 40 Ncm, enabling the immediate placement of esthetic temporary crowns. Saturn is also suitable for cases of open and closed sinus grafting. Expanded diameter threads provide excellent initial stability, even if the residual crestal height is low as only 3 or 4 mm. Furthermore, the Saturn is suitable for implantation for lower premolar and molar extraction sites, when there is adequate room (14 mm mesio-distal).

Greater Bone to Implant Contact (BIC)

Bone to Implant Contact (BIC) is often reduced by up to 50% in extraction sites. Saturn, with its wings, considerably enhances BIC, mechanical torsional support, and overall stability.

Saturn Reduces Displacement and Stress Distribution.

Reduced stress distribution at the neck of the implant may prevent bone loss after loading. Finite Element Analysis demonstrates that the added wings considerably reduce stress distribution at the implant neck, thus reducing the potential for bone loss at the crest.

SMART 1PIECE

Best preservation of bone quantity and improved bone quality

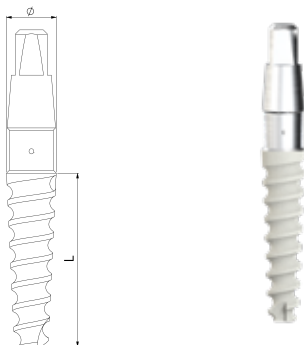

Smart 1Piece Dimensions Premium Package

Implant Diameter Ø [mm]	L = 10 [mm]	L = 11.5 [mm]	L = 13 [mm]	L = 16 [mm]
3.0	CP-1030	CP-1130	CP-1330	CP-1630
3.3	CP-1033	CP-1133	CP-1333	CP-1633

The Smart 1Piece is a threaded, self-tapping, one piece implant with an integrated abutment designed for one stage surgical procedure and cemented restorations.

The Smart 1Piece is designed especially for narrow ridges, and tight spaces, for placement with small bone width and small prosthetic spaces.

- Smart 1Piece uniquely designed features include compress threads for immediate engagement.
- The Smart 1Piece is suitable for all bone types and for immediate loading.
- The insertion of Smart 1Piece implant is a quick and simple one stage procedure.

Due to their innovative geometries and advanced surface morphology, these unique implants offer high initial stability.

They can be used to restore single crowns and anterior cemented bridges. The Smart 1Piece is available in two diameters 3.0 mm and 3.3 mm and has varying heights of 10 mm, 11.5 mm, 13 mm and 16 mm.

Labeling

Capsule Diameter Color Coding



Ø3.3 mm



Ø3.8 mm



Ø4.2 mm



Ø5.0 mm



Ø6.0 mm

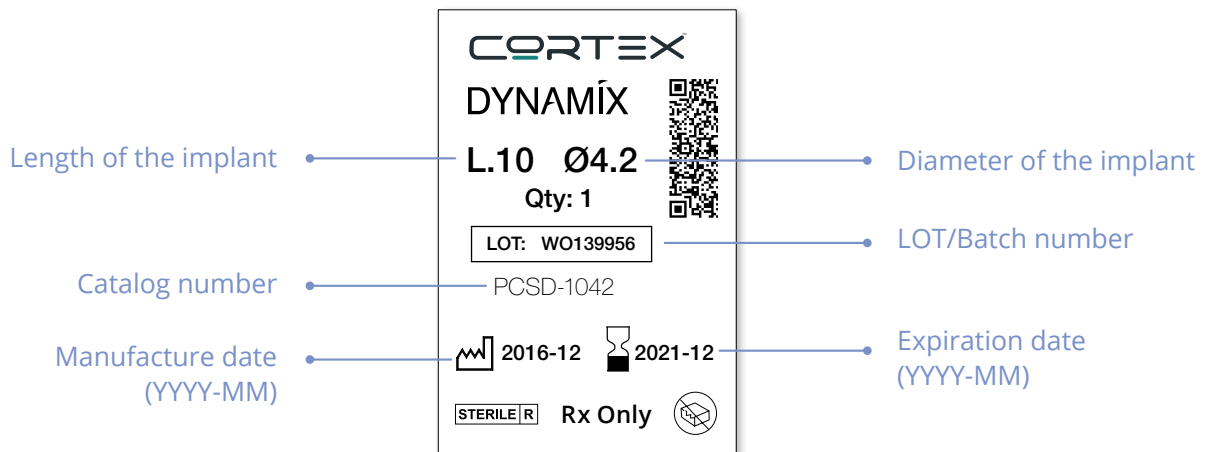

Marks on Package



Cortex products are CE Certified and comply with European Union requirements.



Keep away from sunlight



Do not reuse



Do not use if package damaged



Do not resterilize



Caution, consult accompanying documents



Method of sterilization using radiation



Consult instruction for use symbol

Rx Only

Prescription device

Manufacturer:

Cortex Dental Implants industries Ltd.

Shlomi Industrial Zone, 26 Ya'ara st., Shlomi 22832 Israel.

Tel: +972-4-987-3970, Fax: +972-4-987-3972 // www.cortex-dental.com



EMERGO EUROPE
 Prinsessegracht 20
 2514 AP The Hague
 The Netherlands

Prosthetics Internal Hex Platform



Prosthetic components

Abutments

Healing Cap Abutments



	Narrow	Standard	Standard NEW CONCAVE	Wide
Length	Ø 3.8 [mm]	Ø 4.7 [mm]	Ø 4.7 [mm]	Ø 6 [mm]
2 mm	CO-8102	CO-7102	CO-7102C	
3 mm	CO-8103	CO-7103	CO-7103C	CO-7503
4 mm	CO-8104	CO-7104	CO-7104C	CO-7504
5 mm	CO-8105	CO-7105	CO-7105C	CO-7505
6 mm	CO-8106	CO-7106	CO-7106C	CO-7506
7 mm	CO-8107	CO-7107		

* Hand Tightening with the 1.25 hex driver.

Titanium Anatomic Abutments



	Premium	Straight	Straight NEW CONCAVE	Angulated 15°	Angulated 15° NEW CONCAVE	Angulated 25°	Angulated 25° NEW CONCAVE
Collar Height	Ø 4.8 [mm]	Ø 4.7 [mm]	Ø 4.7 [mm]	Ø 5.3 [mm]	Ø 4.7 [mm]	Ø 5.3 [mm]	Ø 4.7 [mm]
1 mm		CO-9001	CO-9001C	CO-9115	CO-9115C	CO-9125	CO-9125C
1.5 mm	CO-8036						
2 mm		CO-9002	CO-9002C	CO-9215	CO-9215C	CO-9225	CO-9225C
3 mm	CO-8037	CO-9003	CO-9003C	CO-9315	CO-9315C	CO-9325	CO-9325C
4 mm		CO-9004		CO-9415		CO-9425	
Height [mm]	6	8.5	8.5	8.5	8.5	8.5	8.5

* Lingual step increasing up to 1 mm.

Titanium Standard Abutments



	Wide	Straight	Straight NEW CONCAVE	Angulated 15°	Angulated 25°
Height H [mm]	Ø 6 [mm]	Ø 4.7 [mm]	Ø 4.7 [mm]	Ø 4.7 [mm]	Ø 4.7 [mm]
9 mm	CO-8200	CO-8000	CO-8000C	CO-8015	CO-8025
12 mm		CO-8100	CO-8100C	CO-8115	CO-8125
Collar Height	1 mm	1 mm	2 MM	1 mm	1.5 mm

Titanium Slim Abutments

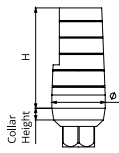

	Straight with Collar	Narrow	Angulated 15°	Angulated 25°
Collar Height	Ø 4.4 [mm]	Ø 3.8 [mm]	Ø 3.8 [mm]	Ø 3.8 [mm]
1 mm	CO-8111	CO-8028 CO-8029 CO-8031	CO-8032	CO-8033
2 mm	CO-8112			
3 mm	CO-8113			
4 mm	CO-8114			
Height				
5 mm		CO-8028		
7 mm	CO-8111	CO-8029		
	CO-8112			
	CO-8113			
	CO-8114			
9 mm		CO-8031	CO-8032	CO-8033

* For narrow areas or narrow emergence profiles.

- Used for cement retained, single, or multiple prosthetic units.
- Titanium Alloy (Ti 6Al-4V ELI).
- Includes abutment screw CO-S030.
- Final Torque 30 Ncm.
- Compatible for implant 3.3, 3.8, 4.2, 5, 6 mm.

Prosthetics

Temporary Anatomic Abutments PEEK

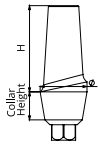

	Straight		Angulated 15°		Angulated 25°	
	Ø 5.2 [mm]	NEW CONCAVE Ø 4.7 [mm]	Ø 5.2 [mm]	NEW CONCAVE Ø 4.7 [mm]	Ø 5.2 [mm]	NEW CONCAVE Ø 4.7 [mm]
	CO-PA003	CO-PA003C	CO-PA153	CO-PA153C	CO-PA253	CO-PA253C
Collar Height	3.0	3.0	3.0	3.0	3.0	3.0
Height [mm]	8.5	8.5	8.5	8.5	8.5	8.5

- Used for cement or screw retained provisional restorations.
- Used for immediate or delayed loading for single or multiple prosthetic units.
- Includes abutment screw CO-S030.
- Final torque 25Ncm.
- PEEK (Polyetheretherketone).

Castable Anatomic Acetal Abutments

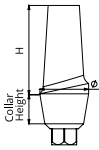

	Straight		Angulated 15°		Angulated 25°	
	Ø 5 [mm]	NEW CONCAVE Ø 4.7 [mm]	Ø 5 [mm]	NEW CONCAVE Ø 4.7 [mm]	Ø 5 [mm]	NEW CONCAVE Ø 4.7 [mm]
Collar Height	1 mm	2 mm	3 mm	1 mm	2 mm	3 mm
	CO-AA001	CO-AA001C	CO-AA151	CO-AA151C	CO-AA251	CO-AA251C
	CO-AA002	CO-AA002C	CO-AA152	CO-AA152C	CO-AA252	CO-AA252C
	CO-AA003	CO-AA003C	CO-AA153	CO-AA153C	CO-AA253	CO-AA253C
Height [mm]	8.5	8.5	8.5	8.5	8.5	8.5

Custom Castable Abutments

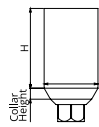

	Ø 4.9 [mm]	Ø 4.5 [mm]	Ø 4.5 [mm]	NEW CONCAVE Ø 4.7 [mm]	Ø 4.5 [mm]
	CO-5010 Hex	CO-5020 Hex	CO-9701Hex	CO-9701C Hex	CO-9700 Hex
	CO-5030 Non Hex	CO-5000 Non Hex	CO-9711 Non Hex	CO-9711C Non Hex	CO-9710 Non Hex
Collar Height	1 mm	0.5 mm	2 mm	2 mm	2 mm
Height [mm]	7.0	10.5	10.0	10.0	10.0

* Chrome cobalt base with Delrin® sleeve.

* Chrome cobalt with Delrin® sleeve.

* Titanium base with Delrin® sleeve.

- Used for cement or screw retained, single prosthetic units.
- Acetal (burn-out plastic).
- Includes abutment screw CO-S030.
- Final torque 30 Ncm.

Aesthetic Connection Abutment

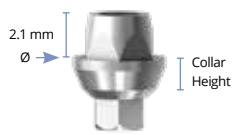

Diameter Ø	Collar Height	Cat. Number
4.7 mm	0.5 mm	CO-6105
4.7 mm	1.5 mm	CO-6115
4.7 mm	2.5 mm	CO-6125

* Includes compatible screw based on collar height.

Screw for Aesthetic Connection Abutment

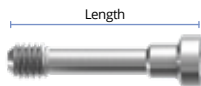

Length [mm]	Cat. Number
10.4 mm	CO-S060
10.8 mm	CO-S061
12 mm	CO-S062

* Not available separately.

Plastic Sleeve for Aesthetic Connection Abutment

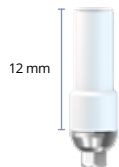

		Cat. Number
 Hex	Aesthetic connection Abutment	CO- 6605
 Non Hex		CO- 6606

* Acetal (burn-out plastic). Height and geometry customizable.

- Used for multiple-unit restorations at the abutment level, cast alloy bars for overdentures and fixed/detachable restorations.
- Titanium alloy (Ti 6Al-4V ELI).
- Final Torque 30 Ncm.

Prosthetics

Impression Components

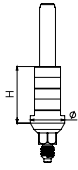

Indirect Transfer Copings
(Open tray)

Indirect Transfer Concave
(Open tray)

Direct Pick-up Snap Copings
(closed tray)

Height	Cat. Number	NEW CONCAVE Cat. Number	Cat. Number
9 mm	CO-8060		CO-8060C
13 mm	CO-8065		CO-8065C
* Includes Compatible screw CS-8065. * Used to make an open tray, implant level impression.		* Includes Compatible screw CS-8065. * Used to make an open tray, implant level impression.	
* Snap-in technique.			

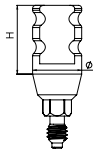

Indirect Short Transfer Copings
(closed tray)

Indirect Transfer Copings
(closed tray)

Diameter Ø	Cat. Number	NEW CONCAVE Cat. Number	Cat. Number	NEW CONCAVE Cat. Number	
3.8 mm	CO-8070		CO-8075		
4.7 mm	CO-8080	CO-8080C	CO-8085	CO-8085C	
* Includes CO-S040 screw		* Includes CO-S040 screw		* Includes CO-S070 screw	

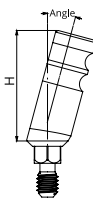

Angulated Transfer 15°

Angulated Transfer 25°

Height	Cat. Number	Cat. Number
10 mm	CO-8071	CO-8072

* Used for closed tray impression when implants are tilted.

* Includes abutment screw CO-S030.

- Hand tighten with 1.25 mm hex driver.
- Compatible to all implant level components with a 3.65 platform.

Analogs

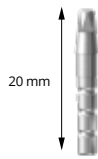

One Piece Analog

CO-8049

* Compatible to Smart 1Piece implants only.



Abutment Analog

CO-8047

* Compatible to premium abutment only CO-8036.
* For abutment level impressions.

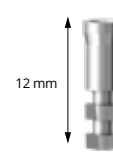

Implant Analog

CO-8040

* Compatible to all implant level components with a 3.65 platform.

Titanium Screws



Abutment Screw Long (7.8 mm)

Length	Ø	Cat. Number
7.8 mm	2.2 mm	CO-S030

- * Used with 1.25 mm hex driver.
- * Final torque 30 Ncm.
- * Included with all abutments
- * Titanium Alloy - Ti 6Al-4V ELI



Cover Screw

CS-0010

- * Fits all internal hex connection Implants.
- * Torque 15 Ncm.
- * Thread 1-72 UNF
- * Included with all internal hex connection Implants.
- * Titanium Alloy - Ti 6Al-4V ELI

Prosthetics

Ball Attachment System

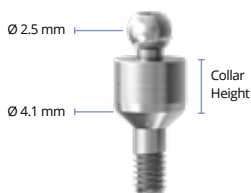

Ball Attachment	
Collar Height	Cat. Number
1 mm	CO-6201
2 mm	CO-6202
3 mm	CO-6203
4 mm	CO-6204
5 mm	CO-6205
6 mm	CO-6206

- * Used for retention of removable overdentures.
- * Titanium alloy (Ti 6Al-4V ELI).
- * Final Torque 20 Ncm.



Metallic Attachment Housing (Cap)		
Ø	Height	Cat. Number
5 mm	3 mm	CO-6030

- * For POM (Polyacetal) housing.
- * Used for overdentures pickup or soldering.
- * Stainless steel.



Retention Cap POM (Polyacetal)		
Color	Retention	Cat. Number
Transparent	Standard	CO-6020
Pink	Soft	CO-6021
Yellow	Extra soft	CO-6022

MULTI-UNIT

The Multi-Unit abutments range features straight bases and bases with angle correction of 18° and 30° and 1-5 mm of collar heights for all implant platforms including narrow implants.

Multi-Unit Hex Abutments

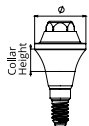

	Straight	Angulated 18°	Angulated 30°
Collar Height	Ø 5 [mm]	Ø 5 [mm]	Ø 5 [mm]
1 mm	CO-5100	CO-5118	CO-5130
2 mm	CO-5200	CO-5218	CO-5230
3 mm	CO-5300	CO-5318	CO-5330
4 mm	CO-5400	CO-5418	CO-5430
5 mm	CO-5500	CO-5518	CO-5530

* All angulated Multi-Unit abutments Includes screw CO-MUS65+CT-MUP10.

Healing Cap for Multi-Unit Abutment



Material	Feature	Diameter	Height	Cat. Number
Titanium	Healing Cap	5 mm	4.2 mm	MU-50HC

Sleeves for Multi-Unit Abutment

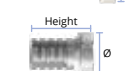

Material	Feature	Diameter	Height	Cat. Number
Acetal	Non Hex	5 mm	12 mm	MU-50PL
Acetal	With Hex	5 mm	12 mm	MU-50SPL
Titanium	Short	5 mm	7 mm	MU-50TS
Titanium	Long	5 mm	12 mm	MU-50TL

* All sleeves Includes screw MU-S020.

Transfer for Multi-Unit Abutment

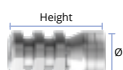

Diameter	Height	Cat. Number
5 mm	11 mm	MU-5060
5 mm	9 mm	MU-5080

* MU-5060 is for open tray. MU-5080 is for close tray.

* Includes screw MU-S060/ MU-S080

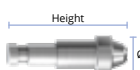

Multi-Unit Abutment Analog





Diameter	Height	Cat. Number
5 mm	16 mm	MU-8041

Multi-Units





Screw for Multi-Unit Abutment

		Thread	Cat. Number
	Screw for Sleeves	M1.4	MU-S020
	Screw for Angulated Abutment	1-72UNF	CO-MUS65

Multi-Unit Straight Abutments Tighten Key

	Length	Cat. Number
	5 mm	CT-MU01
	10 mm	CT-MU00
	15 mm	CT-MU02

CAD/CAM for Multi-Unit Abutment

		Cat. Number
	Scan Body for Multi-Unit	CO-SBMU
	Long Ti-Base for Multi-Unit Abutment	MU-LTSST
	Short Ti-Base for Multi-Unit Abutment	MU-STSST
	Screw for short Multi-Unit Ti-Base	MU-S010
	Screw for long Multi-Unit Ti-Base	MU-S020

* CO-SBMU Includes screw MU-SSB (Hand Tightend).

* MU-LTSST Includes screw MU-S020.

* MU-STSST Includes screw MU-S010.



Digital Solutions

Guided Surgery & CAD/CAM Solutions



Guided Surgery

Cortex guided surgery procedure is a technique of guided surgery based on the following principles:

- Fully guided surgical procedure, from virtual implant planning to clinical execution, by using the surgical guide and an advanced Cortex Guided Surgery Kit.
- Management of any type of implant rehabilitation intervention.
- Open system and completely applicable to Cortex implant platforms, and fully integrated with open software for virtual design with laboratory prosthetic modeling of provisional solutions.
- Accurate three-dimensional reproduction of the patient anatomy by integrating digital DICOM DATA from CBCT and Intra/Extra-Oral optical scans.
- Utilizing certified and validated software programs allows the clinician to develop a complete and precise pre-implant diagnosis, and creates a custom virtual surgical plan, enabling predictable outcomes.
- The latest CAD/CAM technology is used to prepare a virtual wax-up of the prosthetic solution, allowing a prosthetic driven virtual implant planning, as well as surgical guide design and manufacturing.

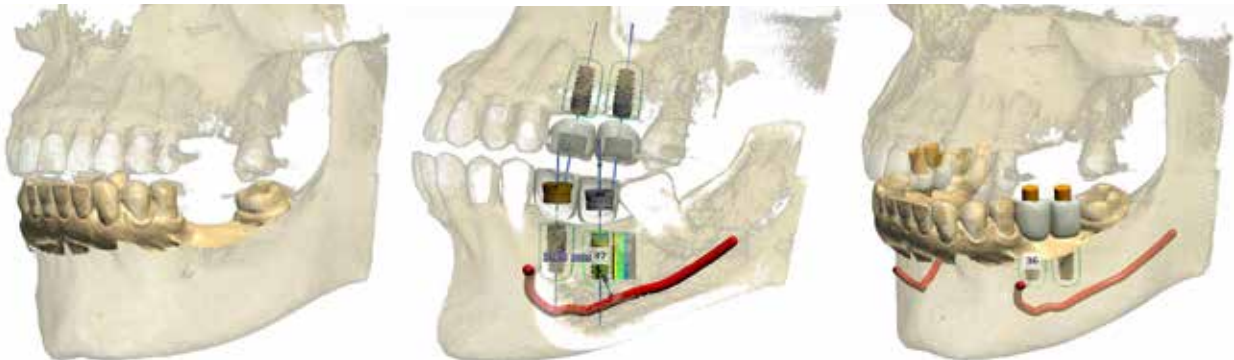

Guided Surgical Kit - CK-GS11

- Advanced drills design featuring: bone preserving geometry and external irrigation pass to reduce the heat produced during the drilling procedure.
- DLC (diamond-like-carbon) coating to reduce friction, prevent corrosion and extending drills life.
- All components of the surgical workflow features a built-in guiding cylinder and stopper compatible with the sleeves, allowing the clinician to perform a FULLY GUIDED spoon-less procedure.
- High-quality drills, including dedicated dense bone drills set and bone profilers, made by Maillefer Switzerland.
- High quality and easy-in-use prosthetic tools and torque ratchet. Intuitive kit layout, enabling easy-to-use workflow.
- One universal kit for all Cortex implants systems provides a full solution for all clinical constraints.

From virtual planning to final restoration

- Supported by: 3shape, 3Diemme, Zirkozahn, Exocad, BlueSkyBio, Smop - Swissmeda.
- Digital Lab support from virtual planning to 3D printing or milling of bio-compatible surgical guides.
- High precision 3D printing with 16 - micron slice thickness accuracy.
- Cortex top quality CAD/CAM system provides a full prosthetic solution for temporary and permanent restorations.
- CAD/CAM products range includes: Scan-Bodies, Titanium-Bases, Titanium-Bases for Multi-Units, One-piece Multi Units system and Titanium Pre-Milled abutments.

Fully Guided Surgery Kit CK-GS11 Layout

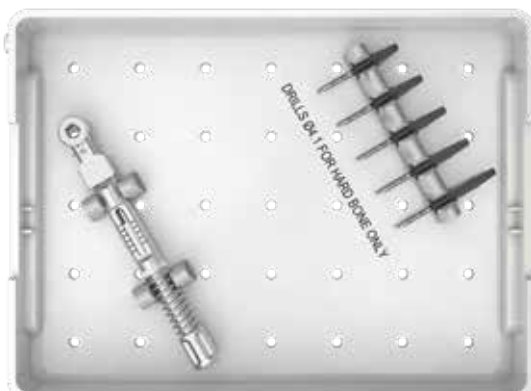
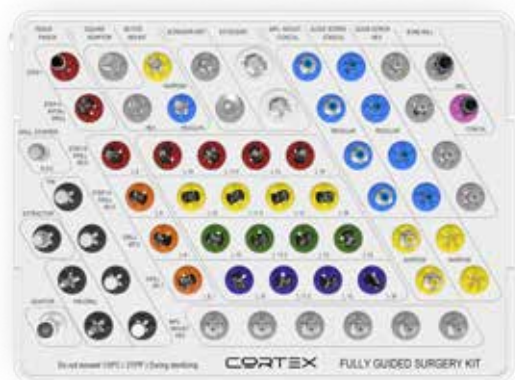



Implant site preparation

Preparation Diagram

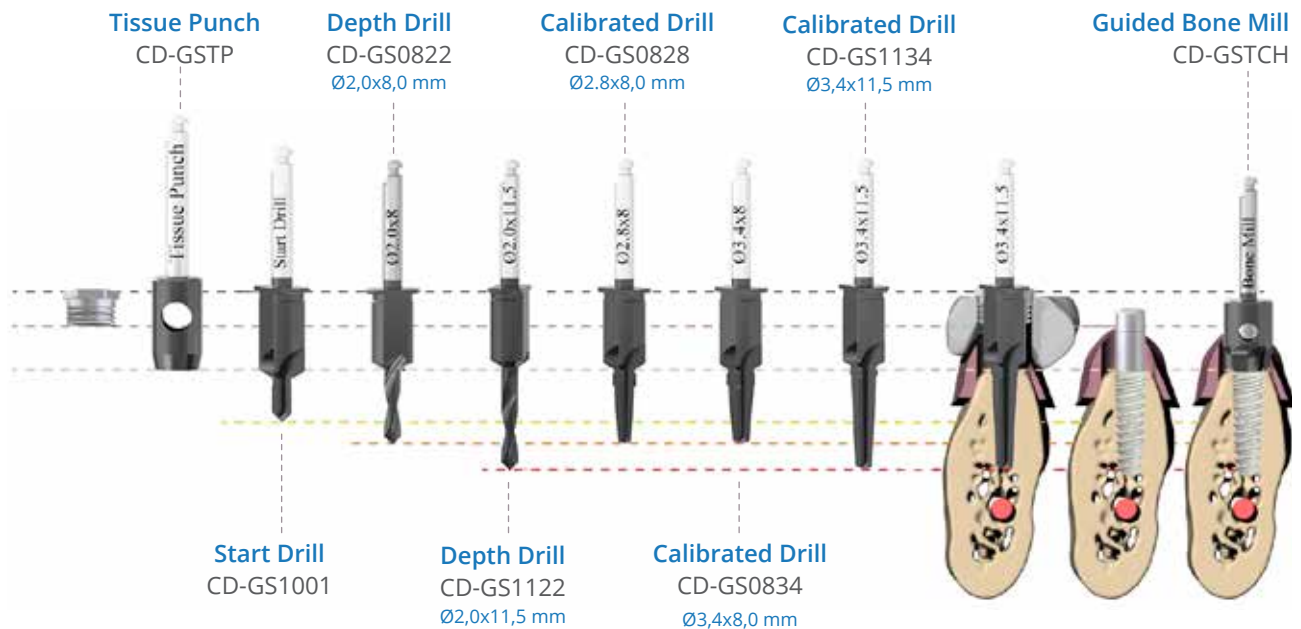
The preparation diagram of the implant site is shown below as an example for $\varnothing 3.8\text{mm}$, length 11.5mm implant.



Cortex Guided Surgery Drills and Tools

Guided Surgery Fixation Pin Drill	
Description	Cat. Number
 <p>The fixation pin drill cuts at the tip. The drill should pass completely through the sleeve to guarantee a firm pin grip.</p>	CD-GSFP
Guided Surgery Fixation Pin	
Description	Cat. Number
 <p>The fixation pin fixes the surgical guide into position. The pin must be pushed all the way through the sleeve.</p>	CT-GSFP
Guided Surgery Tissue Punch	
Description	Cat. Number
 <p>This tool creates a 4.4 mm diameter mucotomy prior to the passage of drills when utilizing a flapless surgical technique.</p>	CD-GSTP

Guided Surgery Drills and Tools



Start Drill	
Description	Cat. Number
The start drill removes the mucosa cut by the mucotomy and prepares the cortical bone for the passage of the first drill.	CD-GS1001



Guided Surgery Depth Drill	
Description	Cat. Number
The depth drills guarantee the initial preparation (2.0 mm diameter) of the implant site for 8, 10, 11.5, 13 and 16mm length implants.	CD-GS0822, CD-GS1022, CD-GS1122, CD-GS1322, CD-GS1622



Guided Surgery Tapered Drill	
Description	Cat. Number
Tapered drills are used to finalize the implant site preparation according to the implant diameter and length.	CD-GS0828, CD-GS1028, CD-GS1128, CD-GS1328, CD-GS1628, CD-GS0834, CD-GS1034, CD-GS1134, CD-GS1334, CD-GS1634, CD-GS0837, CD-GS1037, CD-GS1137, CD-GS1337, CD-GS1637, CD-GS0841, CD-GS1041, CD-GS1141, CD-GS1341, CD-GS1641



Guided Surgery Drill Stopper L2 Ø5	
Description	Cat. Number
Used to reduce 8mm length drills, allowing fully guided placement of L6mm implants.	CD-GSST52



Guided Surgery Implant Mount	
Description	Cat. Number
The main advantage of Cortex Guided Surgery. Used for FULLY GUIDED Implant insertion without removing the surgical guide.	CO-GS5090 (INT HEX), MPR-GS5090 (REGULAR CONICAL), MPN-GS5090 (NARROW CONICAL)

* Includes compatible screw

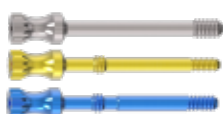

Implant mount screws		
Description	Thread	Cat. Number
Implant mount screw HEX	1-72 UNF	CO-GSS200
Implant mount screw MPN	M1.4	MPN-GSS200
Implant mount screw MPR	M1.6	MPR-GSS200



HandPiece Screwdriver 1.25 L10mm	
Description	Cat. Number
Handpiece screwdriver for tightening the implant mount screw and other prosthetic screws. Length 10mm.	CT-D110



Manual Screwdriver	
Description	Cat. Number
Manual screwdriver for tightening the implant mount screw and other prosthetic screws. Length 10mm.	CT-0220A



Handpiece Implant Driver For Direct Implant Interface (Int. HEX)	
Description	Cat. Number
Length 15mm	CT-H215



Handpiece Implant Driver For Direct Implant Interface (Conical Narrow Platform)	
Description	Cat. Number
Length 15mm	MCT-N215



Handpiece Implant Driver For Direct Implant Interface (Conical Regular Platform)	
Description	Cat. Number
Length 15mm	MCT-R215



Square Adaptor	
Description	Cat. Number
Used as an adapter between the handpiece drivers and square ratchet.	CT-0232



Guided Surgery Motor Adaptor	
Description	Cat. Number
Connector for guiding the implant mount with surgical handpiece. Max torque 60Ncm.	CT-GS400

Guided Surgery Short Extension For Ratchet

Description	Cat. Number
-------------	-------------



Extension for connecting the torque wrench and the implant mount. Max torque 60Ncm. CT-GSS440

Guided Surgery Extension For Ratchet

Description	Cat. Number
-------------	-------------



Long extension for connecting the torque wrench and the implant mount. Max torque 60Ncm. CT-GS440

Guided Surgery Extractor For Implant Mount

Description	Cat. Number
-------------	-------------



Used for removing jammed implant mount from the surgical guide. CT-GS262

Guided Surgery Screws For Bone Mill

Description	Cat. Number
-------------	-------------



Used for guiding the bone mills after removing the surgical guide. CO-GS7000 (INT HEX)
MPR-GS7000 (REGULAR CONICAL)
MPN-GS7000 (NARROW CONICAL)

Guided Surgery Tapered Bone Mill

Description	Cat. Number
-------------	-------------



Used to remove the residual crestal bone to make site preparation for the abutments. To be used AFTER removing the surgical guide. CD-GSTCH (INT HEX)
CD-GSTCC (CONICAL)

Torque Ratchet 15-100 (Ncm)

Description	Cat. Number
-------------	-------------



Used with all applicable components. CT-0863

Cortex Guiding Sleeves

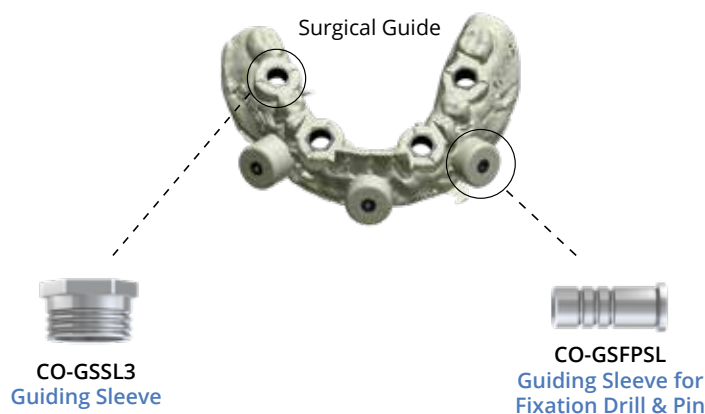

Components for Stone Model Analog Manufacturing

Description	Cat. Number	
Guided Pin Screw For Model Casting		
Guiding Sleeve		
Guided Cylinder For Model Casting		
Implant Analog		
		
		





Guided pin screw for model casting

MPR-GSPS (REGULAR CONICAL)
MPN-GSPS (NARROW CONICAL)
CO-GSPS (INT HEX)

Guided Cylinder For Model Casting

MPR-GSCL (REGULAR CONICAL)
MPN-GSCL (NARROW CONICAL)
CO-GSCL (INT HEX)

Components for Digital Model Analog

Digital Implant Analogs		
Description	Cat. Number	
 Digital Implant Analog HEX	CO-8040D	
 Digital Implant Analog MPN	MPN-8040D	
 Digital Implant Analog MPR	MPR-8040D	
 Digital Implant Analog MPW	MPW-8040D	
 Digital Implant Analog MU	MU-8041D	
* Packed with compatible pin CT-FPDA		

Fixation Pin For Digital Analog		
Description	Cat. Number	
 Used for fixing the analog inside the digital model.	CT-FPDA	



CAD CAM

Digital Dentistry is the art of designing, planning and producing aesthetic and precise dental restorations using virtual software, milling machines and 3D printers. It is becoming a routine in prestige dental practices and laboratories around the world.

Cortex Dental Implants Industries introduces its brand new, top quality CAD/CAM products range, including Scan-Bodies and Titanium-Bases (As well as CEREC compatible Scan posts and Titanium-Bases) for 2.4mm Internal Hex interface and Narrow, Regular and Wide Conical Platforms.

The accuracy and simplicity of Cortex CAD/CAM System plays a major role in creating precise restorations, simple and intuitive workflow and exceptional aesthetic results.

In order to achieve such a high level of components, we established a fully equipped in-house laboratory, featuring state of the art Scanners, 3D printers, Production center and more.

This lab gives us the ability to develop, design and validate our superior quality products, as well as fully support our valuable clients with any issues arising.

Scan Bodies

Scan Bodies are designed to transfer an ultra-precise location of the implant by means of optical scanning. A digital 3D model of the jaw and the implant is created containing all critical restoration parameters such as: Implant position, Implant's Axis angulation and Hexagon Buccal-Lingual orientation. Using this 3D model together with CAD/CAM software, designing and producing of Individual Abutments, Screw Retained Crowns and Bridges, Bars and unlimited variations of Frame-Work, becomes intuitive and precise.

Main characteristics

- Micro-Roughness for enhanced scanning contrast
- Biocompatible – Titanium 6Al4V
- Laser marking for platform identification
- Asymmetrical geometric shape
- Various CAD/CAM systems compatibility
- Intra-oral / Extra-oral use
- Built-in screw

Titanium Bases

Titanium bases (Ti-Bases) are used as joining structures for ceramic restorations such as: Hybrid-Abutments and Screw Retained Crowns and Bridges. Cortex Ti-Bases are produced in accordance with our strict precision and quality standards, ensuring superior aesthetic results.

Our Ti-Bases inclusive range, available in different configurations and heights, provides full cover to all restorations techniques and cases for Individual Crowns (Engaged) and Multi-Teeth restorations (Non-Engaged).

Conical connection Ti-Bases include an anodized connecting screw, compatible with the implant's platform and in accordance with Cortex Conical connection color coding system.



Scan Body

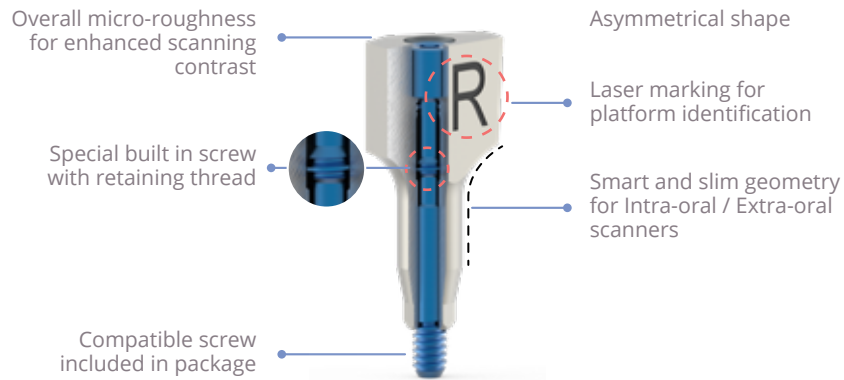

Internal Hex

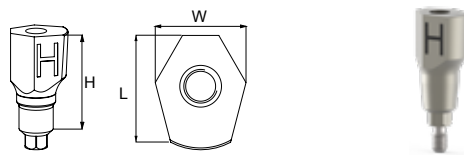

Cat. Number	CO-SBZZ
W [mm]	5
L [mm]	6
H [mm]	11

Conical Connection



Cat. Number	MPN-SBZZ	MPR-SBZZ	MPW-SBZZ
W [mm]	4	4	5
L [mm]	6	6	6
H [mm]	11	11	11

Multi-Unit

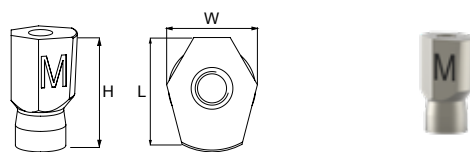

Cat. Number	CO-SBMU
W [mm]	5
L [mm]	6
H [mm]	11

Scan Body - Screw

Internal Hex

Conical Connection

Multi Unit



Cat. Number	CO-S030	MPN-SSB	MPR-SSB	MPW-SSB	MU-SSB
-------------	---------	---------	---------	---------	--------

- * Overall height from Implant top surface = 11mm
- * Includes compatible screw
- * Manual Screw Tightening

Ti-Base - Lock (Engaged)

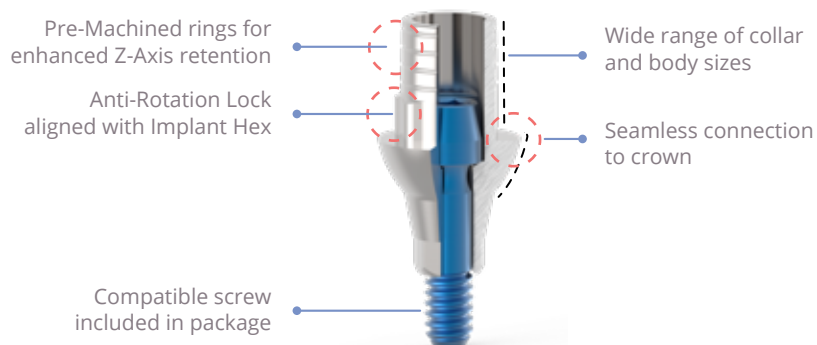

Ti-Base - Screw

Internal Hex

Conical Connection



Cat. Number	CO-S030	MPN-S030	MPR-S030	MPW-S030
-------------	---------	----------	----------	----------

Internal Hex

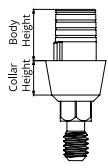

Cat. Number	CO-TBH1	NEW CONCAVE CO-TBH1C	CO-TBH2	NEW CONCAVE CO-TBH2C	CO-TBH3	NEW CONCAVE CO-TBH3C	CO-TBH4	NEW CONCAVE CO-TBH4C
Collar Height [mm]	1	1	1	1	3	3	3	3
Body Height [mm]	4	4	6	6	4	4	6	6
Torque [Ncm]	30	30	30	30	30	30	30	30

Conical Connection

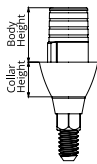

NP

Cat. Number	MPN-TBH1	MPN-TBH2	MPN-TBH3
Collar Height [mm]	1	2	3
Body Height [mm]	4	4	4
Torque [Ncm]	20	20	20

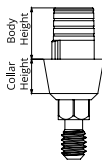

RP

Cat. Number	MPR-TBH1	MPR-TBH2	MPR-TBH3	MPR-TBH4
Collar Height [mm]	1	2	3	4
Body Height [mm]	4	4	4	4
Torque [Ncm]	30	30	30	30

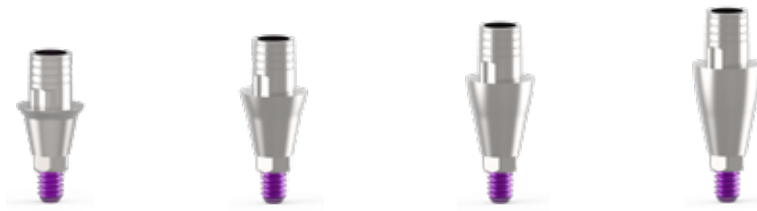
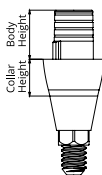

WP

Cat. Number	MPW-TBH1	MPW-TBH2	MPW-TBH3	MPW-TBH4
Collar Height [mm]	1	2	3	4
Body Height [mm]	4	4	4	4
Torque [Ncm]	30	30	30	30

Ti-Base - No Lock (Non Engaged)

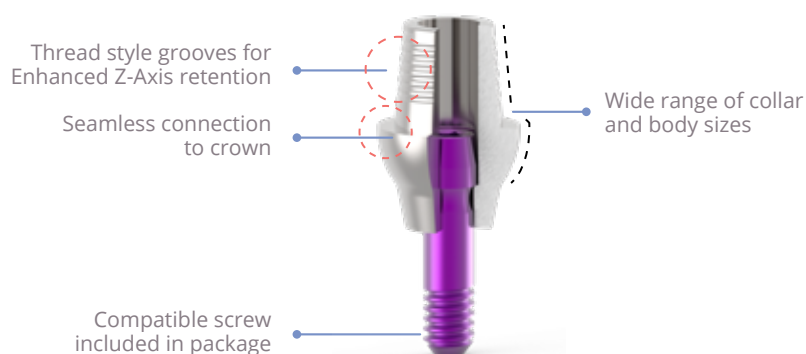

Ti-Base - Screw

Internal Hex

Conical Connection



Internal Hex

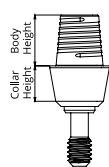

Cat. Number	CO-TBR1	NEW CONCAVE CO-TBR1C	CO-TBR2	NEW CONCAVE CO-TBR2C	CO-TBR3	NEW CONCAVE CO-TBR3C	CO-TBR4	NEW CONCAVE CO-TBR4C
Collar Height [mm]	1	1	1	2	3	3	3	3
Body Height [mm]	4	4	6	6	4	4	6	6
Torque [Ncm]	30	30	30	30	30	30	30	30

Conical Connection

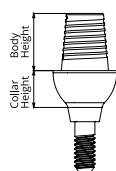

Cat. Number	MPN-TBR1	MPN-TBR2	MPN-TBR3
Collar Height [mm]	1	2	3
Body Height [mm]	4	4	4
Torque [Ncm]	20	20	20

NP



RP

Cat. Number	MPR-TBR1	MPR-TBR2	MPR-TBR3	MPR-TBR4
Collar Height [mm]	1	2	3	4
Body Height [mm]	4	4	4	4
Torque [Ncm]	30	30	30	30



WP

Cat. Number	MPW-TBR1	MPW-TBR2	MPW-TBR3	MPW-TBR4
Collar Height [mm]	1	2	3	4
Body Height [mm]	4	4	4	4
Torque [Ncm]	30	30	30	30

Multi-Unit Ti-Base

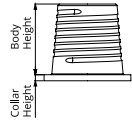

Cat. Number	MU-STSST	MU-LTSST
Collar Height [mm]	0.3	0.7
Body Height [mm]	4	4
Torque [Ncm]	20	20

Multi-Unit Ti-Base Screw



Cat. Number	MU-S010	MU-S020
-------------	---------	---------

Pre-Milled abutments

Internal Hex

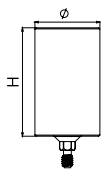

Cat. Number		R9000-R	
Height [mm]		20	
Diameter [mm]		11.5	
Torque [Ncm]		30	

* Includes compatible screw CO-S030

Conical Connection

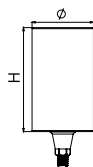

NP

RP

WP



Cat. Number	S9030-R	S9000-R	S9020-R
Height [mm]	20	20	20
Diameter [mm]	11.5	11.5	11.5
Torque [Ncm]	20	30	30

* Includes compatible screw

Screws

NP

RP

WP

Internal Hex

Conical Connection



Cat. Number	CO-S030	MPN-S030	MPR-S030	MPW-S030
Thread	1-72-UNF	M1.4	M1.6	M2

Scan Post

CEREC®
Compatible

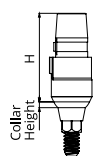

Internal Hex

Conical Connection

NP

RP

WP



Cat. Number	CO-SPCRC	MPN-SPCRC	MPR-SPCRC	MPW-SPCRC
-------------	----------	-----------	-----------	-----------

* Manual tightening

* Includes compatible screw

CEREC Compatible Components

Ti-Base - Lock (Engaged)

CEREC®
Compatible

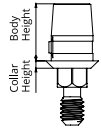

Internal Hex



Conical Connection

Cat. Number	CO-TBCRC	MPN-TBCRC	MPR-TBCRC	MPW-TBCRC
Collar Height [mm]	0.5	1	1	1
Body Height [mm]	4.5	4.5	4.5	4.5
Torque [Ncm]	30	20	30	30

* Includes compatible screw

Ti-Base - No Lock (Non Engaged)

CEREC®
Compatible

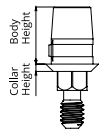

Internal Hex



Conical Connection

Cat. Number	CO-TBCRCR	MPN-TBCRCR	MPR-TBCRCR	MPW-TBCRCR
Collar Height [mm]	0.5	1	1	1
Body Height [mm]	4.5	4.5	4.5	4.5
Torque [Ncm]	30	20	30	30

* Includes compatible screw

Screw



Internal Hex



Conical Connection

Cat. Number	CO-S030	MPN-S030	MPR-S030	MPW-S030
Thread	1-72-UNF	M1.4	M1.6	M2

Surgical instruments



Surgical Instruments

Surgical Kits - Internal Hex

CORKit Basic - CK-0015					
Qty.	Cat. Number	Qty.	Cat. Number	Qty.	Cat. Number
1	CT-0410	1	CD-C042	1	CD-1001
1	CT-0413	1	CT-S115	1	CD-5003
1	CT-0801	1	CT-S215	1	CD-5010
		1	CT-0260	1	CD-C038

* The CORkit basic surgical kit is used for placement of all Cortex's implants with diameters 3.3mm 3.8mm, 4.2mm.

* For larger diameters, additional drills are required.



CORKit Prime - CK-0011					
Qty.	Cat. Number	Qty.	Cat. Number	Qty.	Cat. Number
1	CT-0252	1	CD-C050	1	CD-1001
1	CT-0254	1	CD-C060	1	CD-5003
1	CT-0260	1	CT-S107	1	CD-5010
1	CT-S262	1	CT-S115	1	CD-5137
2	CT-0410	1	CT-S207	1	CD-5140
1	CT-0801	1	CT-S215	1	CD-5148
		1	CT-0242	1	CD-C038
		1	CT-0250	1	CD-C042

* CORkit Prime surgical kit is used for placement of all Cortex's implants.



CORKit Premium - CK-0022					
Qty.	Cat. Number	Qty.	Cat. Number	Qty.	Cat. Number
1	CT-0260	1	CD-C060	1	CD-1001
1	CT-S262	1	CT-S107	1	CD-5003
2	CT-0410	1	CT-S115	1	CD-5010
1	CT-0705	1	CT-S207	1	CD-5137
1	CT-0510	1	CT-S215	1	CD-5140
1	CT-0710	1	CT-0242	1	CD-5148
1	CT-0801	1	CT-0250	1	CD-C038
1	CT-0413	1	CT-0252	1	CD-C042
		1	CT-0254	1	CD-C050

* CORkit Premium surgical kit is used for placement of all Cortex's implants.



Surgical Kits - Conical Connection

CORKit Basic - CK-0042					
Qty.	Cat. Number	Qty.	Cat. Number	Qty.	Cat. Number
1	CT-0410	1	CD-C042	1	CT-0231
1	CT-0413	1	CD-5010	1	MCT-N215
1	CD-1001	1	CT-D115	1	MCT-R215
1	CT-0260	1	CD-5003	1	MCT-W215
1	CT-0801	1	CD-C038		



* The CORkit basic surgical kit is used for placement of all Cortex's implants with diameters 3.3mm 3.8mm, 4.2mm.

* For larger diameters, additional drills are required.

CORKit Premium - CK-0060					
Qty.	Cat. Number	Qty.	Cat. Number	Qty.	Cat. Number
1	CD-1001	1	CT-0231	1	CT-D115
1	CD-5003	1	CT-0232	1	MCT-N210
1	CD-5010	1	CT-0260	1	MCT-N215
1	CD-5137	1	CT-0410	1	MCT-R210
1	CD-5140	2	CT-0413	1	MCT-R215
1	CD-5148	1	CT-0510C	1	MCT-W210
1	CD-C038	1	CT-0705	1	MCT-W215
1	CD-C042	1	CT-0710		
1	CD-C050	1	CT-0801		
1	CD-C060	1	CT-D110		



* CORkit Premium surgical kit is used for placement of all Cortex's implants.

Extension Kits



Hex Surgical Tool Extension Kit - CK-0020					
Qty.	Cat. Number	Qty.	Cat. Number	Qty.	Cat. Number
1	CT-0231	1	CT-0232	1	CT-H220
1	CT-H210	1	CT-H215	1	CT-D110



MPN Surgical Tool Extension Kit - CK-0061					
Qty.	Cat. Number	Qty.	Cat. Number	Qty.	Cat. Number
1	CT-0231	1	CT-0232	1	CT-D110
1	MCT-N210	1	MCT-N215		

* The MPN Surgical tool Extension kit is used for placement of Narrow conical implants.

* For larger implant diameters, additional tools are required.



MPR/MPW Surgical Tool Extension Kit - CK-0062					
Qty.	Cat. Number	Qty.	Cat. Number	Qty.	Cat. Number
1	CT-0231	1	CT-0232	1	CT-D110
1	MCT-R210	1	MCT-R215	1	MCT-W210

* The MPR/MPW Surgical tool Extension kit is used for placement of Regular & Wide conical implants.

- Prior to use, clean and sterilize the surgical tray & instruments according to the instructions stated in Appendix 1.
- Surgical assistants should be familiar with all instruments and their purposes.

Drills



Cortex Stainless steel System Drills	
Description	Cat. Number
Starter drill 1.50 mm	CD-1001
Pilot Drill = 2.00 mm	CD-5003
Drill = 2.8 mm	CD-5010
Conical Drill 3.2 mm for Implant 3.8 mm	CD-C038
* Drill for bone type D1 Dia 3.7 mm for implant 3.8	CD-5137
Conical Drill 3.7 mm for Implant 4.2 mm	CD-C042
* Drill for bone type D1 Dia 4.1 mm for implant 4.2	CD-5140
Conical Drill 4.3 mm for Implant 5.0 mm	CD-C050
* Drill for bone type D1 Dia 4.9 mm for implant 5.0	CD-5148
Conical Drill 5.4 mm for Implant 6.0 mm	CD-C060

* Required for dense bone type D1, D2.

Cortex Drills System

The special conical drill design enables efficient cutting and bone harvesting for autografting.

Drill Markings

The drills are laser marked for depth reference and are measured from the cutting tip by steps of 6 mm, 8 mm, 10 mm, 11.5 mm, 13 mm and 16 mm.

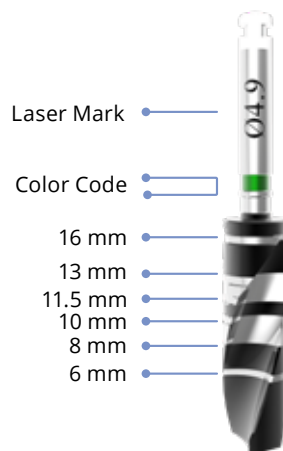

Drilling Sequence Soft Bone - Type D2, D3, D4

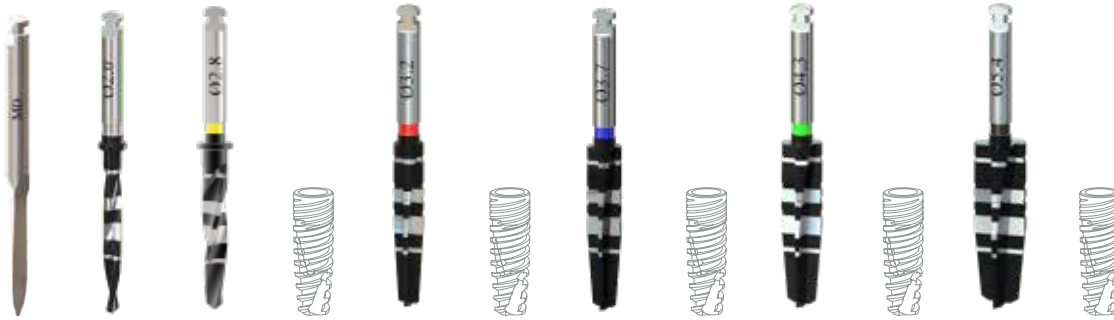

Drilling Sequence: Dense Bone - Type D1

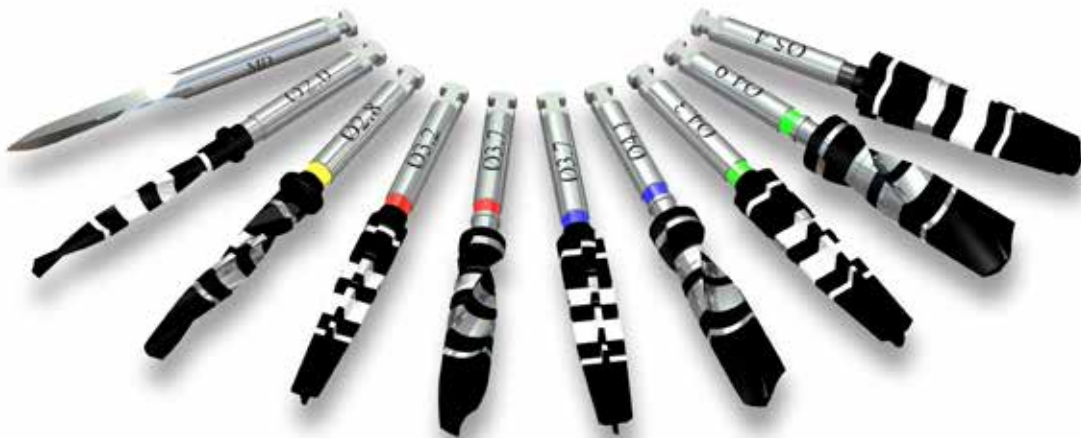
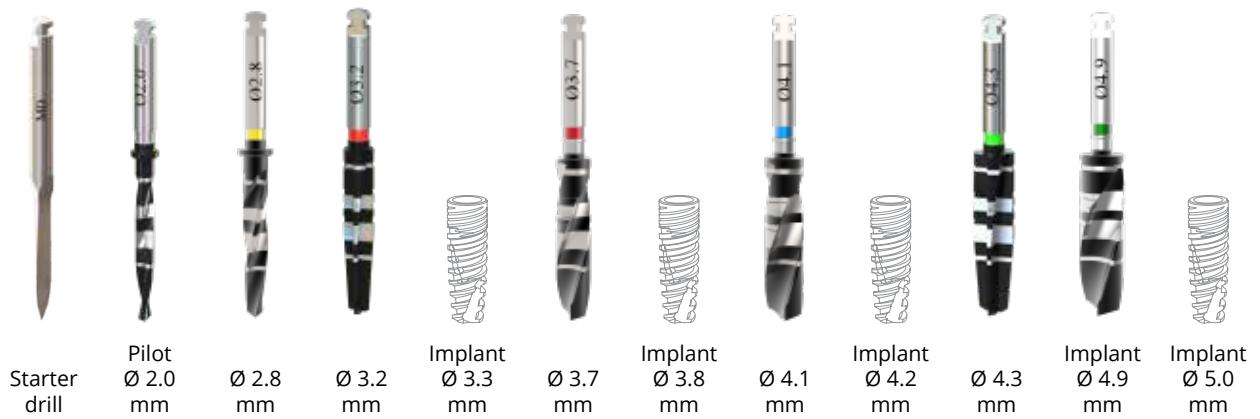

Stoppers Kit

Prime CK-0009	
6 Stoppers for 2 mm	
Description	Cat. Number
Stopper L 6 mm for drill 2 mm	CD-0206
Stopper L 8 mm for drill 2 mm	CD-0208
Stopper L 10 mm for drill 2 mm	CD-0210
Stopper L 11.5 mm for drill 2 mm	CD-0211
Stopper L 13 mm for drill 2 mm	CD-0213
Stopper L 16 mm for drill 2 mm	CD-0216
6 Stoppers for 2.8 mm	
Stopper L 6 mm for drill 2.8 mm	CD-2806
Stopper L 8 mm for drill 2.8 mm	CD-2808
Stopper L 10 mm for drill 2.8 mm	CD-2810
Stopper L 11.5 mm for drill 2.8 mm	CD-2811
Stopper L 13 mm for drill 2.8 mm	CD-2813
Stopper L 16 mm for drill 2.8 mm	CD-2816



Designed by Dr. Meir Mamraev DMD

Premium CK-0010	
6 Stoppers for 2 mm	
Description	Cat. Number
Stopper L 6 mm for drill 2 mm	CD-0206
Stopper L 8 mm for drill 2 mm	CD-0208
Stopper L 10 mm for drill 2 mm	CD-0210
Stopper L 11.5 mm for drill 2 mm	CD-0211
Stopper L 13 mm for drill 2 mm	CD-0213
Stopper L 16 mm for drill 2 mm	CD-0216
6 Stoppers for 2.8 mm	
Stopper L 6 mm for drill 2.8 mm	CD-2806
Stopper L 8 mm for drill 2.8 mm	CD-2808
Stopper L 10 mm for drill 2.8 mm	CD-2810
Stopper L 11.5 mm for drill 2.8 mm	CD-2811
Stopper L 13 mm for drill 2.8 mm	CD-2813
Stopper L 16 mm for drill 2.8 mm	CD-2816

* Comes with two drills - pilot drill 2 mm and drill 2.8 mm.



Designed by Dr. Meir Mamraev DMD

The Drill Stoppers Kit ensures the dental surgeon simple and accurate depth control.

This Stoppers Kit allows well-ordered storage and sterilization. It provides an easy clip on for 2 mm and 2.8 mm drills without manipulation of the stoppers. A safety slide cover is designed to ensure the exact location of stoppers and to prevent errors in assembly.

General Tools

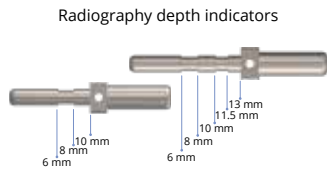

Radiography depth indicators



General Tools	
Length	Cat. Number
Guide Pins	
10 mm	CT-0410
13 mm	CT-0413
Distance Indicator Tool	
	CT-0705
* Used for measuring the distance between the implants with slots for marking.	
Drill Extention	
29 mm	CT-0260
Square Abutment Extractor Key (26 mm)	
26 mm	CT-S262
* Used for extraction of the abutment from the implant without causing stress to the implant and the surrounding bone tissue.	
Holding Key	
	CT-0242
* Used for removing the Pre-Assembled premium abutment	
Depth Probe	
	CT-0710
* Used for osteotomy depth measuring and bone integrity validation.	
* Used for gingival socket depth measuring.	
Direct Handle Driver (Internal Hex)	
	CT-0510
* Used to drive implants into the osteotomy, particularly in the anterior region of the maxilla.	
* Interface with the implant or with the connector abutment CO-8036.	
Direct Handle Driver (Conical)	
	CT-0510C
* Used to drive implants into the osteotomy, particularly in the anterior region of the maxilla.	
* Working with CT-D110, CT-D115, CT-D120, CT-H207, CT-H210, CT-H215, CT-H220, MCT-N207, MCT-N210, MCT-N215, MCT-N220, MCT-R207, MCT-R210, MCT-R215, MCT-R220, MCT-W207, MCT-W210, MCT-W215, MCT-W220.	



Ratchets	
Driver Adaptor for Ratchets - Hand Ratchet	CT-0230
Driver Adaptor for Ratchets - Hex	CT-0231
Driver Adaptor for Ratchets - Square	CT-0232
Ratchet with Titanium handle	CT-0801

* Used for implant installation with the drivers - see table on page 69



Torque Ratchet	
Torque Ratchet (10-40 Ncm), Hex 6.35 mm	CT-0861
Torque Ratchet (15-100 Ncm), Square 4 mm	CT-0863

* Designed to place both implants and abutments with the distinct torque settings scale which adjusts the torque level.
* Simple rotation of the handle's tip adjusts the torque level.

Tools for Smart 1 Piece

Cat. Number



Square and Hex Driver For Smart 1 Piece	CM-0031
---	---------



Smart 1 Piece Adaptor	CM-0032
-----------------------	---------



Hex Driver Mount For Smart 1 Piece	CM-0041
------------------------------------	---------

* Used for installation of Smart 1 Piece implants.







Length



Driver 1.25 mm		
Description	Length	Cat. Number
NEW Prosthetic Hand Driver Hex 1.25	7 mm	CT-0219
Prosthetic Hand Driver Hex 1.25	10 mm	CT-0220
NEW Prosthetic Hand Driver Hex 1.25	18 mm	CT-0224
Driver 1.25; with hex/square Ratchet connection	7 mm	CT-S107
Driver 1.25; with hex/square Ratchet connection	10 mm	CT-S110
Driver 1.25; with hex/square Ratchet connection	15 mm	CT-S115
Motor Mount 1.25 Hex.	22 mm	CT-0250

* For installation or removal of cover screws, healing caps, abutment screws and multi-unit system components.
* The motor-mount is used with a latch type contra-angle hand piece.



Driver 2.42 mm			
	Description	Length	Cat. Number
	Driver 2.42; with hex/square Ratchet connection	7 mm	CT-S207
	Driver 2.42; with hex/square Ratchet connection	10 mm	CT-S210
	Driver 2.42; with hex/square Ratchet connection	15 mm	CT-S215
	Driver 2.42; with hex/square Ratchet connection	18 mm	CT-S218
	Motor Mount 2.42 Hex.	20 mm	CT-0252
	Motor Mount 2.42 Hex.	28 mm	CT-0254

- * For installation of implants at the implant level or at the abutment level in premium packages where the driver interface with the internal hex of the connector abutment CO-8036.
- * The implant insertion with the motor-mount driver should be 30 rpm or less.
- * Notice: the hexagon position of the driver reflects the position of the internal hexagon of the implant.
- * During the insertion try to put the flat part of the hex parallel to the buccal of the bone ridge.

Drivers

Screw Driver

Hex Implant Driver

Conical Implant Drivers



1.25 mm



2.42 mm



Narrow



Regular



Wide

Length	Cat. Number	Cat. Number	Cat. Number	Cat. Number	Cat. Number
NEW 7 mm		CT-H207	MCT-N207	MCT-R207	MCT-W207
10 mm	CT-D110	CT-H210	MCT-N210	MCT-R210	MCT-W210
15 mm	CT-D115	CT-H215	MCT-N215	MCT-R215	MCT-W215
20 mm	CT-D120	CT-H220	MCT-N220	MCT-R220	MCT-W220

1.25mm:

- * For installation or removal of cover screws, healing caps. Abutment screws and multi-unit system components.
- * The motor-mount is used with a latch type contra-angle hand piece.
- * The implant insertion with the motor-mount driver should be 30 rpm or less.
- * **Notice:** the hexagon position of the driver reflects the position of the internal hexagon of the implant.
- * During the insertion try to put the flat part of the hex parallel to the buccal of the bone ridge.
- * Working with CT-0230, CT-0231, CT-0232, and CT-0510C.

Appendix

Cleaning procedure for surgical Basic, Prime & Premium Kits and Instrumentation

- Disassemble the surgical kit and wash the tray using an Enzymatic detergent solution. Rinse the tray with water thoroughly.
- Place the instruments in a beaker of an Enzymatic detergent solution and sonicate for approximately 20 minutes. Let air dry for approximately 5 minutes
- Use only a natural/mild pH Enzymatic detergent solution which is approved for its efficacy (VAH/ DGHM-listing, CE marking, FDA approval) and in accordance with the DFU of the disinfecting solution manufacturer.
- For your own safety, please wear personal protective equipment (gloves, glasses, mask). The disinfecting solution should be aldehyde free and without di- or triethanolamines as corrosion inhibitor.
- Immediately after cleaning, abundant rinsing with distilled or demineralized water should be applied for at least 1 min. Use quality water in accordance with local regulations.
- Let air dry for 5 minutes.
- To avoid the risk of rusting and reducing the disinfecting power due to evaporation and contamination, the disinfectant must be replenished daily.
- Return the instruments to the appropriate locations in the surgical tray.
- Wrap the kit in a double-layer of autoclave-wrap. 10. Sterilize the kit according to the Sterilization Table.

CAUTION: Do not remove the surgical kit from the autoclave until the dry cycle is complete.

CAUTION: The use of hydrogen peroxide or other oxidizing agents will cause damage to the surface of the instruments.

Make sure all instruments are properly dried prior to sterilization all instrumentation before sterilization. Drills and taps should be replaced when a decrease in cutting performance or signs of discoloration are noted.

Cortex recommends replacement of drills after approximately 20 osteotomies, depending on bone density.

Sterilization Table

Autoclave

Steam sterilization - according to the detergent used table

- 135°C (~270°F) 10 minute exposure / 30 minute dry time
- Do not exceed 140°C (284F). Always use the dry cycle.
Each dental office is responsible for the proper, routine sterilization of instruments.
All sterilization techniques should follow the unit manufacturer's guidelines.

Follow the drilling sequences in this guide by placing all the instruments and implants onto the sterile working field in the order they will be used. This assures a natural progression through the case sequence. The Cortex surgical kits are set up in this fashion.

Reference Table

Cat. No.	Description	Page	Cat. No.	Description	Page
BCDL-0833	Magix Dental Implant Ø3.3 L8mm Prime	15	BCSC-1133	Classix Dental Implant Ø3.3mm L11.5mm Prime	31
BCDL-0838	Magix Dental Implant Ø3.8 L0.8mm Prime	15	BCSC-1138	Classix Dental Implant Ø3.8mm L11.5mm Prime	31
BCDL-0842	Magix Dental Implant Ø4.2 L0.8mm Prime	15	BCSC-1142	Classix Dental Implant Ø4.2mm L11.5mm Prime	31
BCDL-1033	Magix Dental Implant Ø3.3 L10mm Prime	15	BCSC-1150	Classix Dental Implant Ø5.0mm L11.5mm Prime	31
BCDL-1038	Magix Dental Implant Ø3.8 L10mm Prime	15	BCSC-1160	Classix Dental Implant Ø6.0mm L11.5mm Prime	31
BCDL-1042	Magix Dental Implant Ø4.2 L10mm Prime	15	BCSC-1333	Classix Dental Implant Ø3.3mm L13mm Prime	31
BCDL-1133	Magix Dental Implant Ø3.3 L11.5mm Prime	15	BCSC-1338	Classix Dental Implant Ø3.8mm L13mm Prime	31
BCDL-1138	Magix Dental Implant Ø3.8 L11.5mm Prime	15	BCSC-1342	Classix Dental Implant Ø4.2mm L13mm Prime	31
BCDL-1142	Magix Dental Implant Ø4.2 L11.5mm Prime	15	BCSC-1350	Classix Dental Implant Ø5.0mm L13mm Prime	31
BCDL-1333	Magix Dental Implant Ø3.3 L13mm Prime	15	BCSC-1360	Classix Dental Implant Ø6.0mm L13mm Prime	31
BCDL-1338	Magix Dental Implant Ø3.8 L13mm Prime	15	BCSC-1633	Classix Dental Implant Ø3.3mm L16mm Prime	31
BCDL-1342	Magix Dental Implant Ø4.2 L13mm Prime	15	BCSC-1638	Classix Dental Implant Ø3.8mm L16mm Prime	31
BCDL-1633	Magix Dental Implant Ø3.3 L16mm Prime	15	BCSC-1642	Classix Dental Implant Ø4.2mm L16mm Prime	31
BCDL-1638	Magix Dental Implant Ø3.8 L16mm Prime	15	BCSD-0642	Dynamix Dental Implant Ø4.2mm L0.6mm Prime	30
BCDL-1642	Magix Dental Implant Ø4.2 L16mm Prime	15	BCSD-0650	Dynamix Dental Implant Ø5.0mm L0.6mm Prime	30
BCSC-0642	Classix Dental Implant Ø4.2mm L0.6mm Prime	31	BCSD-0660	Dynamix Dental Implant Ø6.0mm L0.6mm Prime	30
BCSC-0650	Classix Dental Implant Ø5.0mm L6mm Prime	31	BCSD-0838	Dynamix Dental Implant Ø3.8mm L8mm Prime	30
BCSC-0660	Classix Dental Implant Ø6.0mm L6mm Prime	31	BCSD-0842	Dynamix Dental Implant Ø4.2mm L8mm Prime	30
BCSC-0838	Classix Dental Implant Ø3.8mm L8mm Prime	31	BCSD-0850	Dynamix Dental Implant Ø5.0mm L8mm Prime	30
BCSC-0842	Classix Dental Implant Ø4.2mm L8mm Prime	31	BCSD-0860	Dynamix Dental Implant Ø6.0mm L8mm Prime	30
BCSC-0850	Classix Dental Implant Ø5.0 mm L8mm Prime	31	BCSD-1033	Dynamix Dental Implant Ø3.3mm L10mm Prime	30
BCSC-0860	Classix Dental Implant Ø6.0mm L8mm Prime	31	BCSD-1038	Dynamix Dental Implant Ø3.8mm L10mm Prime	30
BCSC-1033	Classix Dental Implant Ø3.3mm L10mm Prime	31	BCSD-1042	Dynamix Dental Implant Ø4.2mm L10mm Prime	30
BCSC-1038	Classix Dental Implant Ø3.8mm L10mm Prime	31	BCSD-1050	Dynamix Dental Implant Ø5.0mm L10mm Prime	30
BCSC-1042	Classix Dental Implant Ø4.2mm L10mm Prime	31	BCSD-1060	Dynamix Dental Implant Ø6.0mm L10mm Prime	30
BCSC-1050	Classix Dental Implant Ø5.0mm L10mm Prime	31	BCSD-1133	Dynamix Dental Implant Ø3.3mm L11.5mm Prime	30
BCSC-1060	Classix Dental Implant Ø6.0mm L10mm Prime	31	BCSD-1138	Dynamix Dental Implant Ø3.8mm L11.5mm Prime	30

Reference Table

Cat. No.	Description	Page	Cat. No.	Description	Page
BCSD-1142	Dynamix Dental Implant Ø4.2mm L11.5mm Prime	30	BMCC-1338	Conic Classix Implant Ø3.8mm L13mm Prime	13
BCSD-1150	Dynamix Dental Implant Ø5.0mm L11.5mm Prime	30	BMCC-1342	Conic Classix Implant Ø4.2mm L13mm Prime	13
BCSD-1160	Dynamix Dental Implant Ø6.0mm L11.5mm Prime	30	BMCC-1350	Conic Classix Implant Ø5.0mm L13mm Prime	13
BCSD-1333	Dynamix Dental Implant Ø3.3mm L13mm Prime	30	BMCC-1633	Conic Classix Implant Ø3.3mm L16mm Prime	13
BCSD-1338	Dynamix Dental Implant Ø3.8mm L13mm Prime	30	BMCC-1638	Conic Classix Implant Ø3.8mm L16mm Prime	13
BCSD-1342	Dynamix Dental Implant Ø4.2mm L13mm Prime	30	BMCC-1642	Conic Classix Implant Ø4.2mm L16mm Prime	13
BCSD-1350	Dynamix Dental Implant Ø5.0mm L13mm Prime	30	BMCD-0642	Conic Dynamix Implant Ø4.2mm L06mm Prime	12
BCSD-1360	Dynamix Dental Implant Ø6.0mm L13mm Prime	30	BMCD-0650	Conic Dynamix Implant Ø5.0mm L06mm Prime	12
BCSD-1633	Dynamix Dental Implant Ø3.3mm L16mm Prime	30	BMCD-0660	Conic Dynamix Implant Ø6.0mm L06mm Prime	12
BCSD-1638	Dynamix Dental Implant Ø3.8mm L16mm Prime	30	BMCD-0838	Conic Dynamix Implant Ø3.8mm L08mm Prime	12
BCSD-1642	Dynamix Dental Implant Ø4.2mm L16mm Prime	30	BMCD-0842	Conic Dynamix Implant Ø4.2mm L08mm Prime	12
BMCC-0642	Conic Classix Implant Ø4.2mm L06mm Prime	13	BMCD-0850	Conic Dynamix Implant Ø5.0mm L08mm Prime	12
BMCC-0838	Conic Classix Implant Ø3.8mm L08mm Prime	13	BMCD-0860	Conic Dynamix Implant Ø6.0mm L08mm Prime	12
BMCC-0842	Conic Classix Implant Ø4.2mm L08mm Prime	13	BMCD-1030	Conic Dynamix Implant Ø3.0mm L10mm Prime	12
BMCC-0850	Conic Classix Implant Ø5.0mm L08mm Prime	13	BMCD-1033	Conic Dynamix Implant Ø3.3mm L10mm Prime	12
BMCC-0860	Conic Classix Implant Ø6.0mm L08mm Prime	13	BMCD-1038	Conic Dynamix Implant Ø3.8mm L10mm Prime	12
BMCC-1033	Conic Classix Implant Ø3.3mm L10mm Prime	13	BMCD-1042	Conic Dynamix Implant Ø4.2mm L10mm Prime	12
BMCC-1038	Conic Classix Implant Ø3.8mm L10mm Prime	13	BMCD-1050	Conic Dynamix Implant Ø5.0mm L10mm Prime	12
BMCC-1042	Conic Classix Implant Ø4.2mm L10mm Prime	13	BMCD-1060	Conic Dynamix Implant Ø6.0mm L10mm Prime	12
BMCC-1050	Conic Classix Implant Ø5.0mm L10mm Prime	13	BMCD-1130	Conic Dynamix Implant Ø3.0mm L11.5mm Prime	12
BMCC-1060	Conic Classix Implant Ø6.0mm L10mm Prime	13	BMCD-1133	Conic Dynamix Implant Ø3.3mm L11.5mm Prime	12
BMCC-1133	Conic Classix Implant Ø3.3mm L11.5mm Prime	13	BMCD-1138	Conic Dynamix Implant Ø3.8mm L11.5mm Prime	12
BMCC-1138	Conic Classix Implant Ø3.8mm L11.5mm Prime	13	BMCD-1142	Conic Dynamix Implant Ø4.2mm L11.5mm Prime	12
BMCC-1142	Conic Classix Implant Ø4.2mm L11.5mm Prime	13	BMCD-1150	Conic Dynamix Implant Ø5.0mm L11.5mm Prime	12
BMCC-1150	Conic Classix Implant Ø5.0mm L11.5mm Prime	13	BMCD-1160	Conic Dynamix Implant Ø6.0mm L11.5mm Prime	12
BMCC-1160	Conic Classix Implant Ø6.0mm L11.5mm Prime	13	BMCD-1330	Conic Dynamix Implant Ø3.0mm L13mm Prime	12
BMCC-1333	Conic Classix Implant Ø3.3mm L13mm Prime	13	BMCD-1333	Conic Dynamix Implant Ø3.3mm L13mm Prime	12

Cat. No.	Description	Page
BMCD-1338	Conic Dynamix Implant Ø3.8mm L13mm Prime	12
BMCD-1342	Conic Dynamix Implant Ø4.2mm L13mm Prime	12
BMCD-1350	Conic Dynamix Implant Ø5.0mm L13mm Prime	12
BMCD-1630	Conic Dynamix Implant Ø3.0mm L16mm Prime	12
BMCD-1633	Conic Dynamix Implant Ø3.3mm L16mm Prime	12
BMCD-1638	Conic Dynamix Implant Ø3.8mm L16mm Prime	12
BMCD-1642	Conic Dynamix Implant Ø4.2mm L16mm Prime	12
BST-0838	Saturn Dental Implant Ø3.8mm L08mm Prime	32
BST-0842	Saturn Dental Implant Ø4.2mm L08mm Prime	32
BST-1038	Saturn Dental Implant Ø3.8mm L10mm Prime	32
BST-1042	Saturn Dental Implant Ø4.2mm L10mm Prime	32
BST-1138	Saturn Dental Implant Ø3.8mm L11.5mm Prime	32
BST-1142	Saturn Dental Implant Ø4.2mm L11.5mm Prime	32
BST-1338	Saturn Dental Implant Ø3.8mm L13mm Prime	32
BST-1342	Saturn Dental Implant Ø4.2mm L13mm Prime	32
BST-1638	Saturn Dental Implant Ø3.8mm L16mm Prime	32
BST-1642	Saturn Dental Implant Ø4.2mm L16mm Prime	32
CD-0206	Stopper Length 6mm For Drill Ø2mm	66
CD-0208	Stopper Length 8mm For Drill Ø2mm	66
CD-0210	Stopper Length 10mm For Drill Ø2mm	66
CD-0211	Stopper Length 11.5mm For Drill Ø2mm	66
CD-0213	Stopper Length 13mm For Drill Ø2mm	66
CD-0216	Stopper Length 16mm For Drill Ø2mm	66
CD-1001	Starter Drill 1.50mm	64
CD-2806	Stopper Length 6mm For Drill Ø2.8mm	66
CD-2808	Stopper Length 8mm For Drill Ø2.8mm	66
CD-2810	Stopper Length 10mm For Drill Ø2.8mm	66

Cat. No.	Description	Page
CD-2811	Stopper Length 11.5mm For Drill Ø2.8mm	66
CD-2813	Stopper Length 13mm For Drill Ø2.8mm	66
CD-2816	Stopper Length 16mm For Drill Ø2.8mm	66
CD-5003	Pilot Drill Ø2.00mm White	64
CD-5010	Drill Ø2.8mm Yellow	64
CD-5137	Drill For Bone Type D1 Ø3.7mm For Implant 3.8	64
CD-5140	Drill For Bone Type D1 Ø4.1mm For Implant 4.2	64
CD-5148	Drill For Bone Type D1 Ø4.9mm For Implant 5.0	64
CD-C038	Conical Drill Dia. 3.2mm For Implant Ø3.8mm	64
CD-C042	Conical Drill Dia. 3.7mm For Implant Ø4.2mm	64
CD-C050	Conical Drill Dia. 4.3mm For Implant Ø5.0mm	64
CD-C060	Conical Drill Dia. 5.4mm For Implant Ø6.0mm	64
CD-GS0822	GS Drill D2,0x8mm DLC	49
CD-GS0828	GS Drill D2,8x8mm DLC	49
CD-GS0834	GS Drill D3,4x8mm DLC	49
CD-GS0837	GS Drill D3,7x8mm DLC	49
CD-GS0841	GS Drill D4,1x8mm DLC	49
CD-GS1001	GS Start Drill	49
CD-GS1022	GS Drill D2,0x10mm DLC	49
CD-GS1028	GS Drill D2,8x10mm DLC	49
CD-GS1034	GS Drill D3,4x10mm DLC	49
CD-GS1037	GS Drill D3,7x10mm DLC	49
CD-GS1041	GS Drill D4,1x10mm DLC	49
CD-GS1122	GS Drill D2,0x11,5mm DLC	48
CD-GS1128	GS Drill D2,8x11,5mm DLC	49
CD-GS1134	GS Drill D3,4x11,5mm DLC	49
CD-GS1137	GS Drill D3,7x11,5mm DLC	49

Reference Table

Cat. No.	Description	Page	Cat. No.	Description	Page
CD-GS1141	GS Drill D4,1x11.5mm DLC	49	CM-0031	Square Driver One-Piece	68
CD-GS1322	GS Drill D2,0x13mm DLC	49	CM-0032	One-Piece Adaptor	68
CD-GS1328	GS Drill D2,8x13mm DLC	49	CM-0041	Square Basic Driver Mount For One-Piece	68
CD-GS1334	GS Drill D3,4x13mm DLC	49	CO-0620	Pom (Polyacetal) Standard (Yellow)	24
CD-GS1337	GS Drill D3,7x13mm DLC	49	CO-0621	Pom (Polyacetal) Soft (White)	24
CD-GS1341	GS Drill D4,1x13mm DLC	49	CO-0622	Pom (Polyacetal) Hard (Red)	24
CD-GS1622	GS Drill D2,0x16mm DLC	49	CO-0630	Metallic Attachment Housing	24
CD-GS1628	GS Drill D2,8x16mm DLC	49	CO-5000	Plastic Abutment Non Hex	38
CD-GS1634	GS Drill D3,4x16mm DLC	49	CO-5010	Wide Plastic Abutment With Hex	38
CD-GS1637	GS Drill D3,7x16mm DLC	49	CO-5020	Plastic Abutment With Hex	38
CD-GS1641	GS Drill D4,1x16mm DLC	49	CO-5030	Wide Plastic Abutment Non Hex	38
CD-GSFP	GS Fixation Pin Drill	48	CO-5100	Straight Multi-Unit Abutment H1	43
CD-GSST52	GS Stopper L2 Ø 5	49	CO-5118	Angulated Multi-Unit Abutment 18°. H1	43
CD-GSTCC	GS Bone Mill - Chamfer Conical	51	CO-5130	Angulated Multi-Unit Abutment 30°. H1	43
CD-GSTCH	GS Bone Mill - Chamfer	51	CO-5200	Straight Multi-Unit Abutment H2	43
CD-GSTP	GS Tissue Punch	48	CO-5218	Angulated Multi-Unit Abutment 18°. H2	43
CK-0009	Cortex Stoppers Kit- Prime	66	CO-5230	Angulated Multi-Unit Abutment 30°. H2	43
CK-0010	Cortex Stoppers Kit- Premium	66	CO-5300	Straight Multi-Unit Abutment H3	43
CK-0011	Corkit Prime With Tooling	62	CO-5318	Angulated Multi-Unit Abutment 18°. H3	43
CK-0015	Corkit Basic With Tooling	62	CO-5330	Angulated Multi-Unit Abutment 30°. H3	43
CK-0022	Corkit Premium With Tooling	62	CO-5400	Straight Multi-Unit Abutment H4	43
CK-0020	Hex Surgical Tool Extension Kit	63	CO-5418	Angulated Multi-Unit Abutment 18°. H4	43
CK-0042	Surgical Basic Kit Conical Connection	63	CO-5430	Angulated Multi-Unit Abutment 30°. H4	43
CK-0060	Surgical Premium Kit Conical Connection	63	CO-5500	Straight Multi-Unit Abutment H5	43
CK-0061	MPN Surgical Tool Extension Kit	63	CO-5518	Angulated Multi-Unit Abutment 18°. H5	43
CK-0062	MPR/MPW Surgical Tool Extension Kit	63	CO-5530	Angulated Multi-Unit Abutment 30°. H5	43
CK-GS11	Cor Kit Guided Surgery	47	CO-6020	Silicon Cap For Ball 2.5mm-Standard	42

Cat. No.	Description	Page
CO-6021	Silicon Cap For Ball 2.5mm-Soft	42
CO-6022	Silicon Cap For Ball 2.5mm-Extra Soft	42
CO-6030	Metal Cap	42
CO-6105	Aesthetic Connection Abutment L0.5mm	39
CO-6115	Aesthetic Connection Abutment L1.5mm	39
CO-6125	Aesthetic Connection Abutment L2.5mm	39
CO-6201	Ball Attachment 1mm	42
CO-6202	Ball Attachment 2mm	42
CO-6203	Ball Attachment 3mm	42
CO-6204	Ball Attachment 4mm	42
CO-6205	Ball Attachment 5mm	42
CO-6206	Ball Attachment 6mm	42
CO-6605	Plastic Sleeve For Aesthetic Connection Abutment	39
CO-6606	Plastic Sleeve For Aesthetic Connen Abut.non Hex	39
CO-7102	Healing Cap 2mm	36
CO-7103	Healing Cap 3mm	36
CO-7104	Healing Cap 4mm	36
CO-7105	Healing Cap 5mm	36
CO-7106	Healing Cap 6mm	36
CO-7107	Healing Cap 7mm	36
CO-7102C	Concave Hex. Healing Cap 2mm	36
CO-7103C	Concave Hex. Healing Cap 3mm	36
CO-7104C	Concave Hex. Healing Cap 4mm	36
CO-7105C	Concave Hex. Healing Cap 5mm	36
CO-7106C	Concave Hex. Healing Cap 6mm	36
CO-7503	Healing Cap 3mm Wide	36
CO-7504	Healing Cap 4mm Wide	36

Cat. No.	Description	Page
CO-7505	Healing Cap 5mm Wide	36
CO-7506	Healing Cap 6mm Wide	36
CO-8000	Titanium Abutment L9mm	36
CO-8015	Angulated Titanium Abutment 15° L9mm	36
CO-8000C	Concave Straight Hex Abutment L9mm	36
CO-8100C	Concave Straight Hex Abutment L13mm	36
CO-8025	Angulated Titanium Abutment 25° L9mm	36
CO-8028	Titanium Connector Abutment Slim 5mm	37
CO-8029	Titanium Connector Abutment Slim 7mm	37
CO-8031	Titanium Connector Abutment Slim 9mm	37
CO-8032	Angulated Titanium Abutment Slim 15°	37
CO-8033	Angulated Titanium Abutment Slim 25°	37
CO-8036	Titanium Premium Connector Abutment	36
CO-8037	Titanium Connector Abutment 3mm Collar	36
CO-8040	Implant Analog 3.75mm	41
CO-8040D	Digital Implant Analog Hex	52
CO-8047	Connector Abutment Analog	41
CO-8049	Analog-Smart One Piece Square	41
CO-8050	Implant Transfer 9mm - Close Tray	40
CO-8055	Implant Transfer 13mm - Close Tray	40
CO-8060	Indirect Transfer 9mm Open Tray	40
CO-8065	Indirect Transfer 13mm Open Tray	40
CO-8060C	Concave Hex. Transfer 9mm Open Tray	40
CO-8065C	Concave Hex. Transfer 13mm Open Tray	40
CO-8070	Indirect Narrow Transfer For Closed Tray L9mm	40
CO-8071	Angulated Transfer Hexed Platform L9mm 15°	40
CO-8072	Angulated Transfer Hexed Platform L9mm 25°	40

Reference Table

Cat. No.	Description	Page
CO-8075	Indirect Narrow Transfer For Closed Tray L13mm	40
CO-8080	Indirect Standard Transfer For Closed Tray L9mm	40
CO-8085	Indirect Standart Transfer For Closed Tray L13mm	40
CO-8080C	Concave Hex. Transfer For Closed Tray Dia. 4.5mm L9mm	40
CO-8085C	Concave Hex. Transfer For Closed Tray Dia. 4.5mm L13mm	40
CO-8100	Titanium Abutment L13mm	36
CO-8102	Healing Cap 2l Narrow	36
CO-8103	Healing Cap 3l Narrow	36
CO-8104	Healing Cap 4l Narrow	36
CO-8105	Healing Cap 5l Narrow	36
CO-8106	Healing Cap 6l Narrow	36
CO-8107	Healing Cap 7l Narrow	36
CO-8111	Titanium Abutment Collar 1mm	37
CO-8112	Titanium Abutment Collar 2mm	37
CO-8113	Titanium Abutment Collar 3mm	37
CO-8114	Titanium Abutment Collar 4mm	37
CO-8115	Angulated Titanium Abutment 15° L12mm	36
CO-8125	Angulated Titanium Abutment 25° L12mm	36
CO-8200	Titanium Abutment Ø 6.0mm L11mm	36
CO-9001	Anatomic Titanium Abutment L1mm	36
CO-9002	Anatomic Titanium Abutment L2mm	36
CO-9003	Anatomic Titanium Abutment L3mm	36
CO-9004	Anatomic Titanium Abutment L4mm	36
CO-9001C	Anatomic Concave Straight Hex. Abutment L1mm	36
CO-9002C	Anatomic Concave Straight Hex. Abutment L2mm	36
CO-9003C	Anatomic Concave Straight Hex. Abutment L3mm	36
CO-9115	Anatomic Angulated Titanium Abutment 15° L1mm	36

Cat. No.	Description	Page
CO-9125	Anatomic Angulated Titanium Abutment 25° L1mm	36
CO-9215	Anatomic Angulated Titanium Abutment 15° L2mm	36
CO-9225	Anatomic Angulated Titanium Abutment 25° L2mm	36
CO-9315	Anatomic Angulated Titanium Abutment 15° L3mm	36
CO-9115C	Anatomic Concave Angulated Hex. Abutment L1mm 15deg.	36
CO-9215C	Anatomic Concave Angulated Hex. Abutment L2mm 15deg.	36
CO-9315C	Anatomic Concave Angulated Hex. Abutment L3mm 15deg.	36
CO-9325	Anatomic Angulated Titanium Abutment 25° L3mm	36
CO-9415	Anatomic Angulated Titanium Abutment 15° L4mm	36
CO-9425	Anatomic Angulated Titanium Abutment 25° L4mm	36
CO-9125C	Anatomic Concave Angulated Hex. Abutment L1mm 25deg.	36
CO-9225C	Anatomic Concave Angulated Hex. Abutment L2mm 25deg.	36
CO-9325C	Anatomic Concave Angulated Hex. Abutment L3mm 25°.	36
CO-9700	Titanium Abutment Hex Ø 4.5mm	38
CO-9701	Chrome-Cobalt Abutment Hex Ø 4.5mm	38
CO-9710	Titanium Abutment Without Hex Ø 4.5mm	38
CO-9711	Chrome-Cobalt Abutment Without Hex Ø 4.5mm	38
CO-9701C	Chrome-Cobalt Concave Abutment Hex-Dia 4.5mm	38
CO-9711C	Chrome-Cobalt Concave Abutment Without Hex-Dia 4.5mm	38
CO-AA001	Anatomic Abutment For Casting L1mm	38
CO-AA002	Anatomic Abutment For Casting L2mm	38
CO-AA003	Anatomic Abutment For Casting L3mm	38
CO-AA001C	Anatomic Concave Straight Castable Hex. Abutment L1mm	38
CO-AA002C	Anatomic Concave Straight Castable Hex. Abutment L2mm	38
CO-AA003C	Anatomic Concave Straight Castable Hex. Abutment L3mm	38
CO-AA151	Angulated Abutment For Casting 15° L1mm	38
CO-AA152	Angulated Abutment For Casting 15° L2mm	38

Cat. No.	Description	Page
CO-AA153	Angulated Abutment For Casting 15° L3mm	38
CO-AA151C	Anatomic Concave Angulated Castable Hex. Abutment 15deg. L1mm	38
CO-AA152C	Anatomic Concave Angulated Castable Hex. Abutment 15deg. L2mm	38
CO-AA153C	Anatomic Concave Angulated Castable Hex. Abutment 15deg. L3mm	38
CO-AA251	Angulated Abutment For Casting 25° L1mm	38
CO-AA252	Angulated Abutment For Casting 25° L2mm	38
CO-AA253	Angulated Abutment For Casting 25° L3mm	38
CO-AA251C	Anatomic Concave Angulated Castable Hex. Abutment 25deg. L1mm	38
CO-AA252C	Anatomic Concave Angulated Castable Hex. Abutment 25deg. L2mm	38
CO-AA253C	Anatomic Concave Angulated Castable Hex. Abutment 25deg. L3mm	38
CO-GS5090	Gs Implant Mount Int Hex	49
CO-GS7000	Gs Bone Mill Guide Int Hex	51
CO-GSCL	Guided Cylinder For Model Casting Hex	52
CO-GSFP5L	Guided Sleeve For Fixation Pin	51
CO-GSPS	Guided Pin Screw For Model Casting Hex	52
CO-GSS200	Gs Implant Mount Screw Hex	49
CO-GSSL3	Gs Guided Sleeve (Implant) D5 H4	51
MU-SO20	Screw For Multi-Unit Sleeve	44
CO-MUS65	Screw For Angulated Multi-Unit	44
CO-PA003	Temporary Peek Abutment L3mm	38
CO-PA003C	Anatomic Concave Straight Temporary Hex. Abutment L3mm	38
CO-PA153	Angulated Temporary Peek Abutment 15° L3mm	38
CO-PA253	Angulated Temporary Peek Abutment 25° L3mm	38
CO-PA153C	Anatomic Concave Angulated Temporary Hex. Abutment 15deg. L3mm	38
CO-PA253C	Anatomic Concave Angulated Temporary Hex. Abutment 25deg. L3mm	38
CO-S030	Abutment Screw 7.8mm	41
CO-S040	Screw For Short Transfer	40

Cat. No.	Description	Page
CO-S060	Screw For Esthetic Connection Abutment L10.7	39
CO-S061	Screw For Esthetic Connection Abutment L11.3	39
CO-S062	Screw For Esthetic Connection Abutment L12.3	39
CO-S070	Screw For Long Transfer	40
CO-SBMU	Scan Body Ext For Multi-unit	27
CO-SBZZ	Scan Body Ext - Hex.	54
CO-SPCRC	Scanpost For Cerec Hex Platform	59
CO-TBCRC	Tibase For Cerec Hex Platform Lock	60
CO-TBCRCR	Tibase For Cerec Hex Platform No Lock	60
CO-TBH1	Titanium Base Hex. -H1 L4. Lock	56
CO-TBH2	Titanium Base Hex. -H1 L6. Lock	56
CO-TBH3	Titanium Base Hex. -H3 L4. Lock	56
CO-TBH4	Titanium Base Hex. -H3 L6. Lock	56
CO-TBH1C	Concave T-Base Hex. - H1mm L4mm Lock	56
CO-TBH2C	Concave T-Base Hex. - H1mm L6mm Lock	56
CO-TBH3C	Concave T-Base Hex. - H3mm L4mm Lock	56
CO-TBH4C	Concave T-Base Hex. - H3mm L6mm Lock	56
CO-TBR1	Titanium Base Hex. -H1 L4. No Lock	57
CO-TBR2	Titanium Base Hex. -H1 L6. No Lock	57
CO-TBR3	Titanium Base Hex. -H3 L4. No Lock	57
CO-TBR4	Titanium Base Hex. -H3 L6. No Lock	57
CO-TBR1C	Concave T-Base Hex. - H1mm L4mm No Lock	57
CO-TBR2C	Concave T-Base Hex. - H1mm L6mm No Lock	57
CO-TBR3C	Concave T-Base Hex. - H3mm L4mm No Lock	57
CO-TBR4C	Concave T-Base Hex. - H3mm L6mm No Lock	57
CP-1030	Smart One Piece Dental Implant D3.0 L10mm	33
CP-1033	Smart One Piece Dental Implant D3.3 L10mm	33

Reference Table

Cat. No.	Description	Page
CP-1130	Smart One Piece Dental Implant D3.0 L11.5mm	33
CP-1133	Smart One Piece Dental Implant D3.3 L11.5mm	33
CP-1330	Smart One Piece Dental Implant D3.0 L13mm	33
CP-1333	Smart One Piece Dental Implant D3.3 L13mm	33
CP-1630	Smart One Piece Dental Implant D3.0 L16mm	33
CP-1633	Smart One Piece Dental Implant D3.3 L16mm	33
CS-0010	Cover Screw	41
CS-8065	Screw For Indirect Transfer For L13mm	40
CT-0219	Prosthetic Hand Driver Hex=1.25mm L7mm	68
CT-0220	Prosthetic Hand Driver Hex=1.25mm L10mm	50,68
CT-0224	Prosthetic Hand Driver Hex=1.25mm L18mm	68
CT-0230	Hand Ratchet	68
CT-0231	Driver Adaptor For Ratchet Hexed	68
CT-0232	Driver Adaptor For Ratchet Square	50,68
CT-0242	Holding Key Hex. 2.42mm	67
CT-0250	Motor Mount 1.25 Hex L22mm	68
CT-0252	Motor Mount 2.42 Hex L20mm	69
CT-0254	Motor Mount 2.42 Hex L28mm	69
CT-0260	Drill Extension	67
CT-0410	Guide Pin 10mm	67
CT-0413	Guide Pin 13mm	67
CT-0510	Direct Handle Driver	67
CT-0510C	Direct Handle For Handpiece Driver	67
CT-0705	Distance Indicator Tool	67
CT-0710	Depth Probe	67
CT-0801	Ratchet With Titanium Handle	68
CT-0861	Torque Ratchet Hex 6.35mm (10-40 Ncm)	68

Cat. No.	Description	Page
CT-0863	Torque Ratchet Square 4mm (15-100 Ncm)	68
CT-D110	Handpiece Screw Driver 1.25 L10mm	69
CT-D115	Handpiece Screw Driver 1.25 L15mm	69
CT-D120	Handpiece Screw Driver 1.25 L20mm	69
CT-FPDA	Fixation Pin For Digital Analog	52
CT-GS262	GS Extractor For Implant Mount	51
CT-GS400	GS Motor Mount To Implant Mount	50
CT-GS440	GS Extension For Ratchet	51
CT-GSFP	GS Fixation Pin	57
CT-GSS440	GS Implant Mount Short Extender	51
CT-H207	Handpiece Implant Driver 2.42 L7mm For Hexed	65
CT-H210	Handpiece Implant Driver 2.42 L10mm For Hexed	69
CT-H215	Handpiece Implant Driver 2.42 L15mm For Hexed	69
CT-H220	Handpiece Implant Driver 2.42 L20mm For Hexed	69
CT-MU00	Multi-Unit Straight Abutment Tighten Key 10mm	27
CT-MU01	Multi-Unit Straight Abutment Tighten Key 5mm	27
CT-MU02	Multi-Unit Straight Abutment Tighten Key 15mm	27
CT-S107	Square Driver 1.25mm L7mm	68
CT-S110	Square Driver 1.25mm L10mm	68
CT-S115	Square Driver 1.25mm L15mm	68
CT-S207	Hex/Square Driver 2.42mm L7mm	69
CT-S210	Hex/Square Driver 2.42mm L10mm	69
CT-S215	Hex/Square Driver 2.42mm L15mm	69
CT-S218	Hex/Square Driver 2.42mm L18mm	69
CT-S262	Square Abutment Extractor 26mm	67
MCT-N207	Handpiece Implant Driver L7mm For Narrow	67
MCT-N210	Handpiece Implant Driver L10mm For Narrow	67

Cat. No.	Description	Page
MCT-N215	Handpiece Implant Driver L15mm For Narrow	67
MCT-N220	Handpiece Implant Driver L20mm For Narrow	67
MCT-R207	Handpiece Implant Driver L7mm For Regular	67
MCT-R210	Handpiece Implant Driver L10mm For Regular	67
MCT-R215	Handpiece Implant Driver L15mm For Regular	67
MCT-R220	Handpiece Implant Driver L20mm For Regular	67
MCT-W207	Handpiece Implant Driver L7mm For Wide	67
MCT-W210	Handpiece Implant Driver L10mm For Wide	67
MCT-W215	Handpiece Implant Driver L15mm For Wide	67
MCT-W220	Handpiece Implant Driver L20mm For Wide	67
MPN-5100	Straight Multi-Unit Abutment H1 MPN	25
MPN-5118	Angulated Multi-Unit Abutment 18°. H1 MPN	25
MPN-5130	Angulated Multi-Unit Abutment 30°. H1 MPN	25
MPN-5200	Straight Multi-Unit Abutment H2 MPN	25
MPN-5218	Angulated Multi-Unit Abutment 18°. H2 MPN	25
MPN-5230	Angulated Multi-Unit Abutment 30°. H2 MPN	25
MPN-5300	Straight Multi-Unit Abutment H3 MPN	25
MPN-5318	Angulated Multi-Unit Abutment 18°. H3 MPN	25
MPN-5330	Angulated Multi-Unit Abutment 30°. H3 MPN	25
MPN-5400	Straight Multi-Unit Abutment H4 MPN	25
MPN-5418	Angulated Multi-Unit Abutment 18°. H4 MPN	25
MPN-5430	Angulated Multi-Unit Abutment 30°. H4 MPN	25
MPN-5500	Straight Multi-Unit Abutment H5 MPN	25
MPN-5518	Angulated Multi-Unit Abutment 18°. H5 MPN	25
MPN-5530	Angulated Multi-Unit Abutment 30°. H5 MPN	25
MPN-6201	Ball Attachment 1mm MPN	24
MPN-6202	Ball Attachment 2mm MPN	24

Cat. No.	Description	Page
MPN-6203	Ball Attachment 3mm MPN	24
MPN-6204	Ball Attachment 4mm MPN	24
MPN-6205	Ball Attachment 5mm MPN	24
MPN-8000	Titanium Abutment L9mm MPN	18
MPN-8036	Premium Straight Abutment MPN	18
MPN-8040	Implant Analog MPN	24
MPN-8040D	Digital Implant Analog MPN	52
MPN-8060	Indirect Transfer Open Tray MPN	23
MPN-8080	Impression Transfer For Close Tray L9mm MPN	23
MPN-8085	Impression Transfer For Close Tray L12mm MPN	23
MPN-8102	Healing Cap L2 MPN	17
MPN-8103	Healing Cap L3 MPN	17
MPN-8104	Healing Cap L4 MPN	17
MPN-8105	Healing Cap L5 MPN	17
MPN-8106	Healing Cap L6 MPN	17
MPN-8107	Healing Cap L7 MPN	17
MPN-8115	Angulated Titanium Abutment 15°.MPN	19
MPN-8125	Angulated Titanium Abutment 25°. MPN	19
MPN-9001	Anatomic Titanium Abutment L1mm MPN	18
MPN-9002	Anatomic Titanium Abutment L2mm MPN	18
MPN-9003	Anatomic Titanium Abutment L3mm MPN	18
MPN-9004	Anatomic Titanium Abutment L4mm MPN	18
MPN-9115	Anatomic Ang. Titanium Abutment 15° L1mm MPN	19
MPN-9215	Anatomic Ang. Titanium Abutment 15° L2mm MPN	19
MPN-9225	Anatomic Ang Titanium Abutment 25° L2mm MPN	20
MPN-9315	Anatomic Ang. Titanium Abutment 15° L3mm MPN	19
MPN-9325	Anatomic Ang. Titanium Abutment 25° L3mm MPN	20

Reference Table

Cat. No.	Description	Page	Cat. No.	Description	Page
MPN-9415	Anatomic Ang. Titanium Abutment 15° L4mm MPN	19	MPN-TBH3	Titanium Base H3 - Narrow Platform Lock	56
MPN-9425	Anatomic Ang. Titanium Abutment 25° L4mm MPN	20	MPN-TBR1	Titanium Base H1 - Narrow Platform No Lock	57
MPN-9700	Titanium Castable Abutment Hex MPN	22	MPN-TBR2	Titanium Base H2 - Narrow Platform No Lock	57
MPN-9701	Crco Castable Abutment Hex MPN	22	MPN-TBR3	Titanium Base H3 - Narrow Platform No Lock	57
MPN-9710	Titanium Castable Abutment Non Hex MPN	22	MPR-0055	Low Profile Abutment 5.5mm MPR	20
MPN-9711	Crco Castable Abutment Non Hex MPN	22	MPR-0070	Low Profile Abutment 7mm MPR	20
MPN-GS5090	Gs Implant Mount MPN	49	MPR-5100	Straight Multi-Unit Abutment H1 MPR	25
MPN-GS7000	GS Bone Mill Guide MPN	51	MPR-5118	Angulated Multi-Unit Abutment 18°. H1 MPR	25
MPN-GSCL	Guided Cylinder For Model Casting MPN	52	MPR-5130	Angulated Multi-Unit Abutment 30°. H1 MPR	25
MPN-GSPS	Guided Pin Screw For Model Casting MPN	52	MPR-5200	Straight Multi-Unit Abutment H2 MPR	25
MPN-GSS200	GS Implant Mount Screw MPN	49	MPR-5218	Angulated Multi-Unit Abutment 18°. H2 MPR	25
MPN-MUS65	Screw For Narrow Platform Multi-Unit Abutment	26	MPR-5230	Angulated Multi-Unit Abutment 30°. H2 MPR	25
MPN-PA00	Straight Temporary Abutment L2mm MPN	21	MPR-5300	Straight Multi-Unit Abutment H3 MPR	25
MPN-PA15	Angulated Temporary Abutment 15° L2mm MPN	21	MPR-5318	Angulated Multi-Unit Abutment 18°. H3 MPR	25
MPN-PA25	Angulated Temporary Abutment 25° L2mm MPN	21	MPR-5330	Angulated Multi-Unit Abutment 30°. H3 MPR	25
MPN-S010	Cover Screw MPN	17	MPR-5400	Straight Multi-Unit Abutment H4 MPR	25
MPN-S030	Abutment Screw MPN	59, 17	MPR-5418	Angulated Multi-Unit Abutment 18°. H4 MPR	25
MPN-S040	Screw For Short Transfer Close Tray MPN	23	MPR-5430	Angulated Multi-Unit Abutment 30°. H4 MPR	25
MPN-S060	Screw For Indirect Transfer Open Tray MPN	23	MPR-5500	Straight Multi-Unit Abutment H5 MPR	25
MPN-S070	Screw For Long Transfer Close Tray MPN	23	MPR-5518	Angulated Multi-Unit Abutment 18°. H5 MPR	25
MPN-SBZZ	Scan Body Ext - Narrow Platform	54	MPR-5530	Angulated Multi-Unit Abutment 30°. H5 MPR	25
MPN-SPCRC	Scanpost For Cerec Narrow Platform	59	MPR-6201	Ball Attachment 1mm MPR	24
MPN-SSB	Screw For Scan Body For Narrow Platform	55	MPR-6202	Ball Attachment 2mm MPR	24
MPN-TBCRC	Tibase For Cerec Narrow Platform Lock	60	MPR-6203	Ball Attachment 3mm MPR	24
MPN-TBCRCR	Tibase For Cerec Narrow Platform No Lock	60	MPR-6204	Ball Attachment 4mm MPR	24
MPN-TBH1	Titanium Base H1 - Narrow Platform Lock	56	MPR-6205	Ball Attachment 5mm MPR	24
MPN-TBH2	Titanium Base H2 - Narrow Platform Lock	56	MPR-6206	Ball Attachment 6mm MPR	24

Cat. No.	Description	Page
MPR-6207	Ball Attachment 7mm MPR	24
MPR-7102	Healing Cap 2mm MPR	17
MPR-7103	Healing Cap 3mm MPR	17
MPR-7104	Healing Cap 4mm MPR	17
MPR-7105	Healing Cap 5mm MPR	17
MPR-7106	Healing Cap 6mm MPR	17
MPR-7107	Healing Cap 7mm MPR	17
MPR-8000	Titanium Abutment L9mm MPR	18
MPR-8036	Premium Straight Abutment MPR	18
MPR-8040	Implant Analog MPR	24
MPR-8040D	Digital Implant Analog MPR	52
MPR-8060	Indirect Transfer Open Tray MPR	23
MPR-8080	Impression Transfer For Close Tray L9mm MPR	23
MPR-8085	Impression Transfer For Close Tray L12mm MPR	23
MPR-8115	Angulated Titanium Abutment 15°. MPR	19
MPR-8125	Angulated Titanium Abutment 25°. MPR	19
MPR-9001	Anatomic Titanium Abutment L1mm MPR	18
MPR-9002	Anatomic Titanium Abutment L2mm MPR	18
MPR-9003	Anatomic Titanium Abutment L3mm MPR	18
MPR-9004	Anatomic Titanium Abutment L4mm MPR	18
MPR-9115	Anatomic Ang. Titanium Abutment 15°. L1mm MPR	19
MPR-9215	Anatomic Ang. Titanium Abutment 15°. L2mm MPR	19
MPR-9225	Anatomic Ang. Titanium Abutment 25°. L2mm MPR	20
MPR-9315	Anatomic Ang. Titanium Abutment 15°. L3mm MPR	19
MPR-9325	Anatomic Ang. Titanium Abutment 25°. L3mm MPR	20
MPR-9415	Anatomic Ang. Titanium Abutment 15°. L4mm MPR	19
MPR-9425	Anatomic Ang. Titanium Abutment 25°. L4mm MPR	20

Cat. No.	Description	Page
MPR-9700	Titanium Castable Abutment Hex MPR	22
MPR-9701	Crco Castable Abutment Hex MPR	22
MPR-9710	Titanium Castable Abutment Non Hex MPR	22
MPR-9711	Crco Castable Abutment Non Hex MPR	22
MPR-GS5090	GS Implant Mount MPR	49
MPR-GS7000	GS Bone Mill Guide MPR	51
MPR-GSCL	Guided Cylinder For Model Casting MPR	52
MPR-GSPS	Guided Pin Screw For Model Casting MPR	52
MPR-GSS200	GS Implant Mount Screw MPR	49
MPR-MUS65	Screw For Regular Platform Multi-Unit Abutment	26
MPR-PA00	Straight Temporary Abutment L2mm MPR	21
MPR-PA15	Angulated Temporary Abutment 15 L2mm MPR	21
MPR-PA25	Angulated Temporary Abutment 25 L2mm MPR	21
MPR-S010	Cover Screw MPR	17,59
MPR-S030	Abutment Screw MPR	17,59
MPR-S040	Screw For Short Transfer Close Tray MPR	23
MPR-S060	Screw For Indirect Transfer Open Tray MPR	23
MPR-S070	Screw For Long Transfer Close Tray MPR	23
MPR-SBZZ	Scan Body Ext - Regular Platform	54
MPR-SPCRC	Scanpost For Cerec Regular Platform	59
MPR-SSB	Screw For Scan Body For Regular Platform	55
MPR-TBCRC	Tibase For Cerec Regular Platform Lock	60
MPR-TBCRCR	Tibase For Cerec Regular Platform No Lock	60
MPR-TBH1	Titanium Base H1 Regular Platform Lock	56
MPR-TBH2	Titanium Base H2 Regular Platform Lock	56
MPR-TBH3	Titanium Base H3 Regular Platform Lock	56
MPR-TBH4	Titanium Base H4 Regular Platform Lock	56

Reference Table

Cat. No.	Description	Page	Cat. No.	Description	Page
MPR-TBR1	Titanium Base H1 Regular Platform No Lock	58	MPW-7505	Healing Cap 5mm MPW	17
MPR-TBR2	Titanium Base H2 Regular Platform No Lock	58	MPW-7506	Healing Cap 6mm MPW	17
MPR-TBR3	Titanium Base H3 Regular Platform No Lock	58	MPW-8000	Titanium Abutment L9mm MPW	18
MPR-TBR4	Titanium Base H4 Regular Platform No Lock	58	MPW-8036	Premium Straight Abutment MPW	18
MPW-5100	Straight Multi-Unit Abutment H1 MPW	25	MPW-8040	Implant Analog MPW	24
MPW-5118	Angulated Multi-Unit Abutment 18°. H1 MPW	25	MPW-8040D	Digital Implant Analog MPW	52
MPW-5130	Angulated Multi-Unit Abutment 30°. H1 MPW	25	MPW-8060	Indirect Transfer Open Tray MPW	23
MPW-5200	Straight Multi-Unit Abutment H2 MPW	25	MPW-8080	IMPReSSion Transfer For Close Tray L9mm MPW	23
MPW-5218	Angulated Multi-Unit Abutment 18°. H2 MPW	25	MPW-8085	IMPReSSion Transfer For Close Tray L12mm MPW	23
MPW-5230	Angulated Multi-Unit Abutment 30°. H2 MPW	25	MPW-8115	Angulated Titanium Abutment 15°. MPW	19
MPW-5300	Straight Multi-Unit Abutment H3 MPW	25	MPW-8125	Angulated Titanium Abutment 25° MPW	19
MPW-5318	Angulated Multi-Unit Abutment 18°. H3 MPW	25	MPW-9001	Anatomic Titanium Abutment L1mm MPW	18
MPW-5330	Angulated Multi-Unit Abutment 30°. H3 MPW	25	MPW-9002	Anatomic Titanium Abutment L2mm MPW	18
MPW-5400	Straight Multi-Unit Abutment H4 MPW	25	MPW-9003	Anatomic Titanium Abutment L3mm MPW	18
MPW-5418	Angulated Multi-Unit Abutment 18°. H4 MPW	25	MPW-9004	Anatomic Titanium Abutment 4mm L MPW	18
MPW-5430	Angulated Multi-Unit Abutment 30°. H4 MPW	25	MPW-9115	Anatomic Ang. Titanium Abutment 15° L1mm MPW	19
MPW-5500	Straight Multi-Unit Abutment H5 MPW	25	MPW-9125	Anatomic Ang. Titanium Abutment 25° L1mm MPW	20
MPW-5518	Angulated Multi-Unit Abutment 18°. H5 MPW	25	MPW-9215	Anatomic Ang. Titanium Abutment 15° L2mm MPW	19
MPW-5530	Angulated Multi-Unit Abutment 30°. H5 MPW	25	MPW-9225	Anatomic Ang. Titanium Abutment 25° L2mm MPW	20
MPW-6201	Ball Attachment 1mm MPW	24	MPW-9315	Anatomic Ang. Titanium Abutment 15° L3mm MPW	19
MPW-6202	Ball Attachment 2mm MPW	24	MPW-9325	Anatomic Ang. Titanium Abutment 25° L3mm MPW	20
MPW-6203	Ball Attachment 3mm MPW	24	MPW-9415	Anatomic Ang. Titanium Abutment 15° L4mm MPW	19
MPW-6204	Ball Attachment 4mm MPW	24	MPW-9425	Anatomic Ang. Titanium Abutment 25° L4mm MPW	20
MPW-6205	Ball Attachment 5mm MPW	24	MPW-9700	Titanium Castable Abutment Hex MPW	22
MPW-6206	Ball Attachment 6mm MPW	24	MPW-9701	Crco Castable Abutment Hex MPW	22
MPW-7503	Healing Cap 3mm MPW	17	MPW-9710	Titanium Castable Abutment Non Hex MPW	22
MPW-7504	Healing Cap 4mm MPW	17	MPW-9711	Crco Castable Abutment Non Hex MPW	22

Cat. No.	Description	Page
MPW-MUS65	Screw For Wide Platform Multi-Unit Abutment	26
MPW-PA00	Straight Temporary Abutment L2mm MPW	21
MPW-PA15	Angulated Temporary Abutment 15° L2mm MPW	21
MPW-PA25	Angulated Temporary Abutment 25° L2mm MPW	21
MPW-S010	Cover Screw MPW	17
MPW-S030	Abutment Screw MPW	17, 59
MPW-S040	Screw For Long Transfer Close Tray MPW	23
MPW-S060	Screw For Indirect Transfer Open Tray MPW	23
MPW-S070	Screw For Indirect Transfer Close Tray MPW	23
MPW-SBZZ	Scan Body Ext - Wide Platform	54
MPW-SPCRC	Scanpost For Cerec Wide Platform	59
MPW-SSB	Screw For Scan Body For Wide Platform	55
MPW-TBCRC	Tibase For Cerec Wide Platform Lock	60
MPW-TBCRCR	Tibase For Cerec Wide Platform No Lock	60
MPW-TBH1	Titanium Base H1 Wide Platform Lock	56
MPW-TBH2	Titanium Base H2 Wide Platform Lock	56
MPW-TBH3	Titanium Base H3 Wide Platform Lock	58
MPW-TBH4	Titanium Base H4 Wide Platform Lock	58
MPW-TBR1	Titanium Base H1 Wide Platform No Lock	58
MPW-TBR2	Titanium Base H2 Wide Platform No Lock	58
MPW-TBR3	Titanium Base H3 Wide Platform No Lock	58
MPW-TBR4	Titanium Base H4 Wide Platform No Lock	58
MU-5060	Transfer For Multi-Unit Abutment Open Tray	26
MU-5080	Transfer For Multi-Unit Abutment Close Tray	26
MU-50HC	Healing Cap For Multi-Unit Abutment	26
MU-50PL	Plastic Sleeve For Multi-Unit Abutment	26
MU-50SPL	Plastic Sleeve For Single Unit Abutment	26

Cat. No.	Description	Page
MU-50TL	Titanium Sleeve For Multi-Unit Abutment	26
MU-50TS	Short Titanium Sleeve For Multi-Unit Abutment	26
MU-8041	Multi-Unit Abutment Analog	26
MU-8041D	Digital Implant Analog Multi-Unit	52
MU-LTSST	Long Ti-Base (Sleeve) For Multi-Unit Abutment	27
MU-S010	Short Screw For Multi-Unit Abutment	27
MU-S020	Screw For Multi-Unit Abutment	44, 27
MU-S060	Screw For Multi-Unit Open Tray Transfer	26
MU-S080	Screw For Multi-Unit Close Tray Transfer	26
MU-SSB	Screw For Scan Body For Multi-Unit	55
MU-STSST	Short Ti-Base (Sleeve) For Multi-unit Abutment	27
PCSC-0642	Classix Dental Implant Ø 4.2mm L6mm Premium	31
PCSC-0650	Classix Dental Implant Ø 5.0mm L6mm Premium	31
PCSC-0660	Classix Dental Implant Ø 6.0mm L6mm Premium	31
PCSC-0838	Classix Dental Implant Ø 3.8mm L8mm Premium	31
PCSC-0842	Classix Dental Implant Ø 4.2mm L8mm Premium	31
PCSC-0850	Classix Dental Implant Ø 5.0mm L8mm Premium	31
PCSC-0860	Classix Dental Implant Ø 6.0mm L8mm Premium	31
PCSC-1033	Classix Dental Implant Ø 3.3mm L10mm Premium	31
PCSC-1038	Classix Dental Implant Ø 3.8mm L10mm Premium	31
PCSC-1042	Classix Dental Implant Ø 4.2mm L10mm Premium	31
PCSC-1050	Classix Dental Implant Ø 5.0mm L10mm Premium	31
PCSC-1060	Classix Dental Implant Ø 6.0mm L10mm Premium	31
PCSC-1133	Classix Dental Implant Ø 3.3mm L11.5mm Premium	31
PCSC-1138	Classix Dental Implant Ø 3.8mm L11.5mm Premium	31
PCSC-1142	Classix Dental Implant Ø 4.2mm L11.5mm Premium	31
PCSC-1150	Classix Dental Implant Ø 5.0mm L11.5mm Premium	31

Reference Table

Cat. No.	Description	Page	Cat. No.	Description	Page
PCSC-1160	Classix Dental Implant Ø 6.0mm L11.5mm Premium	31	PCSD-1333	Dynamix Dental Implant Ø 3.3mm L13mm Premium	30
PCSC-1333	Classix Dental Implant Ø 3.3mm L13mm Premium	31	PCSD-1338	Dynamix Dental Implant Ø 3.8mm L13mm Premium	30
PCSC-1338	Classix Dental Implant Ø 3.8mm L13mm Premium	31	PCSD-1342	Dynamix Dental Implant Ø 4.2mm L13mm Premium	30
PCSC-1342	Classix Dental Implant Ø 4.2mm L13mm Premium	31	PCSD-1350	Dynamix Dental Implant Ø 5.0mm L13mm Premium	30
PCSC-1350	Classix Dental Implant Ø 5.0mm L13mm Premium	31	PCSD-1360	Dynamix Dental Implant Ø 6.0mm L13mm Premium	30
PCSC-1360	Classix Dental Implant Ø 6.0mm L13mm Premium	31	PCSD-1633	Dynamix Dental Implant Ø 3.3mm L16mm Premium	30
PCSC-1633	Classix Dental Implant Ø 3.3mm L16mm Premium	31	PCSD-1638	Dynamix Dental Implant Ø 3.8mm L16mm Premium	30
PCSC-1638	Classix Dental Implant Ø 3.8mm L16mm Premium	31	PCSD-1642	Dynamix Dental Implant Ø 4.2mm L16mm Premium	30
PCSC-1642	Classix Dental Implant Ø 4.2mm L16mm Premium	31	PST-0838	Saturn Dental Implant Ø 3.8mm L8mm Premium	32
PCSD-0642	Dynamix Dental Implant Ø 4.2mm L6mm Premium	30	PST-0842	Saturn Dental Implant Ø 4.2mm L8mm Premium	32
PCSD-0650	Dynamix Dental Implant Ø 5.0mm L0.6mm Premium	30	PST-1038	Saturn Dental Implant Ø 3.8mm L10mm Premium	32
PCSD-0660	Dynamix Dental Implant Ø 6.0mm L0.6mm Premium	30	PST-1042	Saturn Dental Implant Ø 4.2mm L10mm Premium	32
PCSD-0838	Dynamix Dental Implant Ø 3.8mm L8mm Premium	30	PST-1138	Saturn Dental Implant Ø 3.8mm L11.5mm Premium	32
PCSD-0842	Dynamix Dental Implant Ø 4.2mm L8mm Premium	30	PST-1142	Saturn Dental Implant Ø 4.2mm L11.5mm Premium	32
PCSD-0850	Dynamix Dental Implant Ø 5.0mm L8mm Premium	30	PST-1338	Saturn Dental Implant Ø 3.8mm L13mm Premium	32
PCSD-0860	Dynamix Dental Implant Ø 6.0mm L8mm Premium	30	PST-1342	Saturn Dental Implant Ø 4.2mm L13mm Premium	32
PCSD-1033	Dynamix Dental Implant Ø 3.3mm L10mm Premium	30	PST-1638	Saturn Dental Implant Ø 3.8mm L16mm Premium	32
PCSD-1038	Dynamix Dental Implant Ø 3.8mm L10mm Premium	30	PST-1642	Saturn Dental Implant Ø 4.2mm L16mm Premium	32
PCSD-1042	Dynamix Dental Implant Ø 4.2mm L10mm Premium	30	R9000-R	Pre-Mill Block - Hex.	59
PCSD-1050	Dynamix Dental Implant Ø 5.0mm L10mm Premium	30	S9000-R	Pre-Mill Block - Regular Platform	59
PCSD-1060	Dynamix Dental Implant Ø 6.0mm L10mm Premium	30	S9020-R	Pre-Mill Block - Wide Platform	59
PCSD-1133	Dynamix Dental Implant Ø 3.3mm L11.5mm Premium	30	S9030-R	Pre-Mill Block - Narrow Platform	59
PCSD-1138	Dynamix Dental Implant Ø 3.8mm L11.5mm Premium	30			
PCSD-1142	Dynamix Dental Implant Ø 4.2mm L11.5mm Premium	30			
PCSD-1150	Dynamix Dental Implant Ø 5.0mm L11.5mm Premium	30			
PCSD-1160	Dynamix Dental Implant Ø 6.0mm L11.5mm Premium	30			



We are shaping the future of dentistry, Together.

As medical professionals, we continually seek out the next breakthrough.

A new way to practice top-quality dentistry that is, at once, innovative, personalized, user-friendly and highly effective.

*With extensive background, proven expertise far-sighted vision and pioneering digital capabilities: **We are Cortex.***

Your partner in creating a new era in dental medicine.

CORTEXTM
The Future of Dental Implants

www.cortex-dental.com